





中国认可
国际互认
检测
TESTING
CNAS L0220

Test Report issued under the responsibility of:

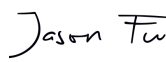

TEST REPORT IEC 62109-1 Safety of Power Converter for use in Photovoltaic Power Systems Part 1: General requirements	
Report Number.....	201015063GZU-001
Date of issue.....	23 Nov 2020
Total number of pages	89 pages
Name of Testing Laboratory preparing the Report	Intertek Testing Services Shenzhen Ltd. Guangzhou Branch Room 02, & 101/E201/E301/E401/E501/E601/E701/E801 of Room 01 1-8/F., No. 7-2. Caipin Road, Science City, GETDD, Guangzhou, Guangdong, China
Applicant's name	Shenzhen SOFARSOLAR Co., Ltd.
Address.....	401, Building 4, AnTongDa Industrial Park, District 68, XingDong Community, XinAn Street, BaoAn District, Shenzhen, China
Test specification:	
Standard	IEC/EN 62109-1:2010 (First Edition)
Test procedure	CE
Non-standard test method	N/A
Test Report Form No.	IEC62109_1B
Test Report Form(s) Originator	VDE Testing and Certification Institute
Master TRF	Dated 2016-04
<p>Copyright © 2016 IEC System of Conformity Assessment Schemes for Electrotechnical Equipment and Components (IECEE System). All rights reserved.</p> <p>This publication may be reproduced in whole or in part for non-commercial purposes as long as the IECEE is acknowledged as copyright owner and source of the material. IECEE takes no responsibility for and will not assume liability for damages resulting from the reader's interpretation of the reproduced material due to its placement and context.</p> <p>If this Test Report Form is used by non-IECEE members, the IECEE/IEC logo and the reference to the CB Scheme procedure shall be removed.</p> <p>This report is not valid as a CB Test Report unless signed by an approved CB Testing Laboratory and appended to a CB Test Certificate issued by an NCB in accordance with IECEE 02.</p>	
General disclaimer:	
<p>The test results presented in this report relate only to the object tested.</p> <p>This report shall not be reproduced, except in full, without the written approval of the Issuing CB Testing Laboratory. The authenticity of this Test Report and its contents can be verified by contacting the NCB, responsible for this Test Report.</p>	

Test item description :	Hybrid inverter
Trade Mark :	
Manufacturer	Same as applicant
Model/Type reference	HYD 6000-EP, HYD 5500-EP, HYD 5000-EP, HYD 4600-EP, HYD 4000-EP, HYD 3680-EP, HYD 3000-EP
Ratings :	See ratings in page 11-12 for details

Responsible Testing Laboratory (as applicable), testing procedure and testing location(s):		
<input checked="" type="checkbox"/>	Testing Laboratory:	Intertek Testing Services Shenzhen Ltd. Guangzhou Branch
Testing location/ address		Room 02, & 101/E201/E301/E401/E501/E601/E701/E801 of Room 01 1-8/F., No. 7-2. Caipin Road, Science City, GETDD, Guangzhou, Guangdong, China
<input type="checkbox"/>	Associated CB Testing Laboratory:	N/A
Testing location/ address		N/A
Tested by (name, function, signature).....:		Jason Fu Supervisor 
Approved by (name, function, signature)....:		Tommy Zhong Technical Manager 
<hr/>		
<input type="checkbox"/>	Testing procedure: CTF Stage 1:	N/A
Testing location/ address		N/A
Tested by (name, function, signature).....:		N/A
Approved by (name, function, signature)....:		N/A
<hr/>		
<input type="checkbox"/>	Testing procedure: CTF Stage 2:	N/A
Testing location/ address		N/A
Tested by (name + signature)		N/A
Witnessed by (name, function, signature) .:		N/A
Approved by (name, function, signature)....:		N/A
<hr/>		
<input type="checkbox"/>	Testing procedure: CTF Stage 3:	N/A
<input type="checkbox"/>	Testing procedure: CTF Stage 4:	N/A
Testing location/ address		N/A
Tested by (name, function, signature).....:		N/A
Witnessed by (name, function, signature) .:		N/A
Approved by (name, function, signature)....:		N/A
Supervised by (name, function, signature) :		N/A

List of Attachments (including a total number of pages in each attachment): N/A	
Summary of testing:	
Tests performed (name of test and test clause): All applicable tests	Testing location: Intertek Testing Services Shenzhen Ltd. Guangzhou Branch Room 02, & 101/E201/E301/E401/E501/E601/E701/E801 of Room 01 1-8/F., No. 7-2. Caipin Road, Science City, GETDD, Guangzhou, Guangdong, China
Summary of compliance with National Differences (List of countries addressed): N/A	
<input checked="" type="checkbox"/> The product fulfils the requirements of IEC/EN 62109-1:2010 (First Edition)	

Copy of marking plate:









The artwork below may be only a draft. The use of certification marks on a product must be authorized by the respective NCBs that own these marks.



SOFAR SOLAR
Hybrid Inverter

Model No:	HYD 6000-EP
Max.DC Input Voltage	600V
Operating MPPT Voltage Range	90V~580V
MAX.PV Isc	2x18A
Battery Type	Lead-acid,Lithium-ion
Battery Voltage Range	42-58V
Max.Charging Current	100A
Max.Discharging Current	100A
Max.Charging&Discharging Power	5000W
Nominal Grid Voltage	230Vac
Nominal Output Voltage	230Vac
Max.Output Current	27.3A
Nominal Grid Frequency	50/60Hz
Power Factor	1(adjustable+/-0.8)
Nominal Output Power	6000W
Backup Rated Current	22.7A
Backup Rated Apparent Power	5000VA
Ingress Protection	IP 65
Operating Temperature Range	-30~+60°C
Protective Class	Class I

Manufacturer : Shenzhen SOFARSOLAR Co., Ltd.
 Address : 401, Building 4, AnTongDa Industrial Park,
 District 68, XingDong Community,XinAn Street,
 BaoAn District, Shenzhen, China
 VDE0126-1-1,VDE-AR-N4105
 G98,AS4777,UTE C15-712-1























































SOFAR SOLAR
Hybrid Inverter

Model No:	HYD 5500-EP
Max.DC Input Voltage	600V
Operating MPPT Voltage Range	90V~580V
MAX.PV Isc	2x18A
Battery Type	Lead-acid,Lithium-ion
Battery Voltage Range	42-58V
Max.Charging Current	100A
Max.Discharging Current	100A
Max.Charging&Discharging Power	5000W
Nominal Grid Voltage	230Vac
Nominal Output Voltage	230Vac
Max.Output Current	25.0A
Nominal Grid Frequency	50/60Hz
Power Factor	1(adjustable+/-0.8)
Nominal Output Power	5000W
Backup Rated Current	22.7A
Backup Rated Apparent Power	5000VA
Ingress Protection	IP 65
Operating Temperature Range	-30~+60°C
Protective Class	Class I

Manufacturer : Shenzhen SOFARSOLAR Co., Ltd.
 Address : 401, Building 4, AnTongDa Industrial Park,
 District 68, XingDong Community,XinAn Street,
 BaoAn District, Shenzhen, China
 VDE0126-1-1,VDE-AR-N4105
 G98,AS4777,UTE C15-712-1

<p style="text-align: center;">SOFAR SOLAR Hybrid Inverter</p> <p>Model No: HYD 5000-EP</p> <table border="0"> <tr><td>Max.DC Input Voltage</td><td>600V</td></tr> <tr><td>Operating MPPT Voltage Range</td><td>90V~580V</td></tr> <tr><td>MAX.PV Isc</td><td>2x18A</td></tr> <tr><td>Battery Type</td><td>Lead-acid,Lithium-ion</td></tr> <tr><td>Battery Voltage Range</td><td>42-58V</td></tr> <tr><td>Max.Charging Current</td><td>100A</td></tr> <tr><td>Max.Discharging Current</td><td>100A</td></tr> <tr><td>Max.Charging&Discharging Power</td><td>5000W</td></tr> <tr><td>Nominal Grid Voltage</td><td>230Vac</td></tr> <tr><td>Nominal Output Voltage</td><td>230Vac</td></tr> <tr><td>Max.Output Current</td><td>21.7A</td></tr> <tr><td>Nominal Grid Frequency</td><td>50/60Hz</td></tr> <tr><td>Power Factor</td><td>1(adjustable+/-0.8)</td></tr> <tr><td>Nominal Output Power</td><td>5000W</td></tr> <tr><td>Backup Rated Current</td><td>22.7A</td></tr> <tr><td>Backup Rated Apparent Power</td><td>5000VA</td></tr> <tr><td>Ingress Protection</td><td>IP 65</td></tr> <tr><td>Operating Temperature Range</td><td>-30~+60°C</td></tr> <tr><td>Protective Class</td><td>Class I</td></tr> </table> <p>Manufacturer : Shenzhen SOFARSOLAR Co., Ltd. Address : 401, Building 4, AnTongDa Industrial Park, District 68, XingDong Community,XinAn Street, BaoAn District, Shenzhen, China VDE0126-1-1,VDE-AR-N4105 G98,AS4777,UTE C15-712-1</p> <p style="text-align: right;"></p> <p>      </p>	Max.DC Input Voltage	600V	Operating MPPT Voltage Range	90V~580V	MAX.PV Isc	2x18A	Battery Type	Lead-acid,Lithium-ion	Battery Voltage Range	42-58V	Max.Charging Current	100A	Max.Discharging Current	100A	Max.Charging&Discharging Power	5000W	Nominal Grid Voltage	230Vac	Nominal Output Voltage	230Vac	Max.Output Current	21.7A	Nominal Grid Frequency	50/60Hz	Power Factor	1(adjustable+/-0.8)	Nominal Output Power	5000W	Backup Rated Current	22.7A	Backup Rated Apparent Power	5000VA	Ingress Protection	IP 65	Operating Temperature Range	-30~+60°C	Protective Class	Class I	<p style="text-align: center;">SOFAR SOLAR Hybrid Inverter</p> <p>Model No: HYD 4600-EP</p> <table border="0"> <tr><td>Max.DC Input Voltage</td><td>600V</td></tr> <tr><td>Operating MPPT Voltage Range</td><td>90V~580V</td></tr> <tr><td>MAX.PV Isc</td><td>2x18A</td></tr> <tr><td>Battery Type</td><td>Lead-acid,Lithium-ion</td></tr> <tr><td>Battery Voltage Range</td><td>42-58V</td></tr> <tr><td>Max.Charging Current</td><td>100A</td></tr> <tr><td>Max.Discharging Current</td><td>100A</td></tr> <tr><td>Max.Charging&Discharging Power</td><td>5000W</td></tr> <tr><td>Nominal Grid Voltage</td><td>230Vac</td></tr> <tr><td>Nominal Output Voltage</td><td>230Vac</td></tr> <tr><td>Max.Output Current</td><td>20.9A</td></tr> <tr><td>Nominal Grid Frequency</td><td>50/60Hz</td></tr> <tr><td>Power Factor</td><td>1(adjustable+/-0.8)</td></tr> <tr><td>Nominal Output Power</td><td>4600W</td></tr> <tr><td>Backup Rated Current</td><td>20.9A</td></tr> <tr><td>Backup Rated Apparent Power</td><td>4600VA</td></tr> <tr><td>Ingress Protection</td><td>IP 65</td></tr> <tr><td>Operating Temperature Range</td><td>-30~+60°C</td></tr> <tr><td>Protective Class</td><td>Class I</td></tr> </table> <p>Manufacturer : Shenzhen SOFARSOLAR Co., Ltd. Address : 401, Building 4, AnTongDa Industrial Park, District 68, XingDong Community,XinAn Street, BaoAn District, Shenzhen, China VDE0126-1-1,VDE-AR-N4105 G98,AS4777,UTE C15-712-1</p> <p style="text-align: right;"></p> <p>      </p>	Max.DC Input Voltage	600V	Operating MPPT Voltage Range	90V~580V	MAX.PV Isc	2x18A	Battery Type	Lead-acid,Lithium-ion	Battery Voltage Range	42-58V	Max.Charging Current	100A	Max.Discharging Current	100A	Max.Charging&Discharging Power	5000W	Nominal Grid Voltage	230Vac	Nominal Output Voltage	230Vac	Max.Output Current	20.9A	Nominal Grid Frequency	50/60Hz	Power Factor	1(adjustable+/-0.8)	Nominal Output Power	4600W	Backup Rated Current	20.9A	Backup Rated Apparent Power	4600VA	Ingress Protection	IP 65	Operating Temperature Range	-30~+60°C	Protective Class	Class I
Max.DC Input Voltage	600V																																																																												
Operating MPPT Voltage Range	90V~580V																																																																												
MAX.PV Isc	2x18A																																																																												
Battery Type	Lead-acid,Lithium-ion																																																																												
Battery Voltage Range	42-58V																																																																												
Max.Charging Current	100A																																																																												
Max.Discharging Current	100A																																																																												
Max.Charging&Discharging Power	5000W																																																																												
Nominal Grid Voltage	230Vac																																																																												
Nominal Output Voltage	230Vac																																																																												
Max.Output Current	21.7A																																																																												
Nominal Grid Frequency	50/60Hz																																																																												
Power Factor	1(adjustable+/-0.8)																																																																												
Nominal Output Power	5000W																																																																												
Backup Rated Current	22.7A																																																																												
Backup Rated Apparent Power	5000VA																																																																												
Ingress Protection	IP 65																																																																												
Operating Temperature Range	-30~+60°C																																																																												
Protective Class	Class I																																																																												
Max.DC Input Voltage	600V																																																																												
Operating MPPT Voltage Range	90V~580V																																																																												
MAX.PV Isc	2x18A																																																																												
Battery Type	Lead-acid,Lithium-ion																																																																												
Battery Voltage Range	42-58V																																																																												
Max.Charging Current	100A																																																																												
Max.Discharging Current	100A																																																																												
Max.Charging&Discharging Power	5000W																																																																												
Nominal Grid Voltage	230Vac																																																																												
Nominal Output Voltage	230Vac																																																																												
Max.Output Current	20.9A																																																																												
Nominal Grid Frequency	50/60Hz																																																																												
Power Factor	1(adjustable+/-0.8)																																																																												
Nominal Output Power	4600W																																																																												
Backup Rated Current	20.9A																																																																												
Backup Rated Apparent Power	4600VA																																																																												
Ingress Protection	IP 65																																																																												
Operating Temperature Range	-30~+60°C																																																																												
Protective Class	Class I																																																																												
<p style="text-align: center;">SOFAR SOLAR Hybrid Inverter</p> <p>Model No: HYD 4000-EP</p> <table border="0"> <tr><td>Max.DC Input Voltage</td><td>600V</td></tr> <tr><td>Operating MPPT Voltage Range</td><td>90V~580V</td></tr> <tr><td>MAX.PV Isc</td><td>2x18A</td></tr> <tr><td>Battery Type</td><td>Lead-acid,Lithium-ion</td></tr> <tr><td>Battery Voltage Range</td><td>42-58V</td></tr> <tr><td>Max.Charging Current</td><td>85A</td></tr> <tr><td>Max.Discharging Current</td><td>85A</td></tr> <tr><td>Max.Charging&Discharging Power</td><td>4250W</td></tr> <tr><td>Nominal Grid Voltage</td><td>230Vac</td></tr> <tr><td>Nominal Output Voltage</td><td>230Vac</td></tr> <tr><td>Max.Output Current</td><td>20.0A</td></tr> <tr><td>Nominal Grid Frequency</td><td>50/60Hz</td></tr> <tr><td>Power Factor</td><td>1(adjustable+/-0.8)</td></tr> <tr><td>Nominal Output Power</td><td>4000W</td></tr> <tr><td>Backup Rated Current</td><td>18.2A</td></tr> <tr><td>Backup Rated Apparent Power</td><td>4000VA</td></tr> <tr><td>Ingress Protection</td><td>IP 65</td></tr> <tr><td>Operating Temperature Range</td><td>-30~+60°C</td></tr> <tr><td>Protective Class</td><td>Class I</td></tr> </table> <p>Manufacturer : Shenzhen SOFARSOLAR Co., Ltd. Address : 401, Building 4, AnTongDa Industrial Park, District 68, XingDong Community,XinAn Street, BaoAn District, Shenzhen, China VDE0126-1-1,VDE-AR-N4105 G98,AS4777,UTE C15-712-1</p> <p style="text-align: right;"></p> <p>      </p>	Max.DC Input Voltage	600V	Operating MPPT Voltage Range	90V~580V	MAX.PV Isc	2x18A	Battery Type	Lead-acid,Lithium-ion	Battery Voltage Range	42-58V	Max.Charging Current	85A	Max.Discharging Current	85A	Max.Charging&Discharging Power	4250W	Nominal Grid Voltage	230Vac	Nominal Output Voltage	230Vac	Max.Output Current	20.0A	Nominal Grid Frequency	50/60Hz	Power Factor	1(adjustable+/-0.8)	Nominal Output Power	4000W	Backup Rated Current	18.2A	Backup Rated Apparent Power	4000VA	Ingress Protection	IP 65	Operating Temperature Range	-30~+60°C	Protective Class	Class I	<p style="text-align: center;">SOFAR SOLAR Hybrid Inverter</p> <p>Model No: HYD 3680-EP</p> <table border="0"> <tr><td>Max.DC Input Voltage</td><td>600V</td></tr> <tr><td>Operating MPPT Voltage Range</td><td>90V~580V</td></tr> <tr><td>MAX.PV Isc</td><td>2x18A</td></tr> <tr><td>Battery Type</td><td>Lead-acid,Lithium-ion</td></tr> <tr><td>Battery Voltage Range</td><td>42-58V</td></tr> <tr><td>Max.Charging Current</td><td>80A</td></tr> <tr><td>Max.Discharging Current</td><td>80A</td></tr> <tr><td>Max.Charging&Discharging Power</td><td>4000W</td></tr> <tr><td>Nominal Grid Voltage</td><td>230Vac</td></tr> <tr><td>Nominal Output Voltage</td><td>230Vac</td></tr> <tr><td>Max.Output Current</td><td>16.0A</td></tr> <tr><td>Nominal Grid Frequency</td><td>50/60Hz</td></tr> <tr><td>Power Factor</td><td>1(adjustable+/-0.8)</td></tr> <tr><td>Nominal Output Power</td><td>3680W</td></tr> <tr><td>Backup Rated Current</td><td>13.6A</td></tr> <tr><td>Backup Rated Apparent Power</td><td>3680VA</td></tr> <tr><td>Ingress Protection</td><td>IP 65</td></tr> <tr><td>Operating Temperature Range</td><td>-30~+60°C</td></tr> <tr><td>Protective Class</td><td>Class I</td></tr> </table> <p>Manufacturer : Shenzhen SOFARSOLAR Co., Ltd. Address : 401, Building 4, AnTongDa Industrial Park, District 68, XingDong Community,XinAn Street, BaoAn District, Shenzhen, China VDE0126-1-1,VDE-AR-N4105 G98,AS4777,UTE C15-712-1</p> <p style="text-align: right;"></p> <p>      </p>	Max.DC Input Voltage	600V	Operating MPPT Voltage Range	90V~580V	MAX.PV Isc	2x18A	Battery Type	Lead-acid,Lithium-ion	Battery Voltage Range	42-58V	Max.Charging Current	80A	Max.Discharging Current	80A	Max.Charging&Discharging Power	4000W	Nominal Grid Voltage	230Vac	Nominal Output Voltage	230Vac	Max.Output Current	16.0A	Nominal Grid Frequency	50/60Hz	Power Factor	1(adjustable+/-0.8)	Nominal Output Power	3680W	Backup Rated Current	13.6A	Backup Rated Apparent Power	3680VA	Ingress Protection	IP 65	Operating Temperature Range	-30~+60°C	Protective Class	Class I
Max.DC Input Voltage	600V																																																																												
Operating MPPT Voltage Range	90V~580V																																																																												
MAX.PV Isc	2x18A																																																																												
Battery Type	Lead-acid,Lithium-ion																																																																												
Battery Voltage Range	42-58V																																																																												
Max.Charging Current	85A																																																																												
Max.Discharging Current	85A																																																																												
Max.Charging&Discharging Power	4250W																																																																												
Nominal Grid Voltage	230Vac																																																																												
Nominal Output Voltage	230Vac																																																																												
Max.Output Current	20.0A																																																																												
Nominal Grid Frequency	50/60Hz																																																																												
Power Factor	1(adjustable+/-0.8)																																																																												
Nominal Output Power	4000W																																																																												
Backup Rated Current	18.2A																																																																												
Backup Rated Apparent Power	4000VA																																																																												
Ingress Protection	IP 65																																																																												
Operating Temperature Range	-30~+60°C																																																																												
Protective Class	Class I																																																																												
Max.DC Input Voltage	600V																																																																												
Operating MPPT Voltage Range	90V~580V																																																																												
MAX.PV Isc	2x18A																																																																												
Battery Type	Lead-acid,Lithium-ion																																																																												
Battery Voltage Range	42-58V																																																																												
Max.Charging Current	80A																																																																												
Max.Discharging Current	80A																																																																												
Max.Charging&Discharging Power	4000W																																																																												
Nominal Grid Voltage	230Vac																																																																												
Nominal Output Voltage	230Vac																																																																												
Max.Output Current	16.0A																																																																												
Nominal Grid Frequency	50/60Hz																																																																												
Power Factor	1(adjustable+/-0.8)																																																																												
Nominal Output Power	3680W																																																																												
Backup Rated Current	13.6A																																																																												
Backup Rated Apparent Power	3680VA																																																																												
Ingress Protection	IP 65																																																																												
Operating Temperature Range	-30~+60°C																																																																												
Protective Class	Class I																																																																												











Hybrid Inverter

Model No: HYD 3000-EP

Max.DC Input Voltage	600V
Operating MPPT Voltage Range	90V~580V
MAX.PV Isc	2x18A
Battery Type	Lead-acid,Lithium-ion
Battery Voltage Range	42-58V
Max.Charging Current	75A
Max.Discharging Current	75A
Max.Charging&Discharging Power	3750W
Nominal Grid Voltage	230Vac
Nominal Output Voltage	230Vac
Max.Output Current	15.0A
Nominal Grid Frequency	50/60Hz
Power Factor	1(adjustable+/-0.8)
Nominal Output Power	3000W
Backup Rated Current	13.6A
Backup Rated Apparent Power	3000VA
Ingress Protection	IP 65
Operating Temperature Range	-30-+60°C
Protective Class	Class I

Manufacturer : Shenzhen SOFARSOLAR Co., Ltd.
Address : 401, Building 4, AnTongDa Industrial Park,
District 68, XingDong Community,XinAn Street,
BaoAn District, Shenzhen, China
 VDE0126-1-1,VDE-AR-N4105
 G98,AS4777,UTE C15-712-1

Note:

1. The above markings are the minimum requirements required by the safety standard. For the final production samples, the additional markings which do not give rise to misunderstanding may be added.
2. Label is attached on the side surface of enclosure and visible after installation.

Test item particulars :			
Equipment mobility :	<input type="checkbox"/> movable	<input type="checkbox"/> hand-held	<input type="checkbox"/> stationary
	<input checked="" type="checkbox"/> fixed	<input type="checkbox"/> transportable	<input type="checkbox"/> for building-in
Connection to the mains :	<input type="checkbox"/> pluggable equipment	<input type="checkbox"/> direct plug-in	
	<input checked="" type="checkbox"/> permanent connection	<input type="checkbox"/> for building-in	
Environmental category :	<input checked="" type="checkbox"/> outdoor	<input type="checkbox"/> indoor unconditional	<input type="checkbox"/> indoor conditional
Over voltage category Mains :	<input type="checkbox"/> OVC I	<input type="checkbox"/> OVC II	<input checked="" type="checkbox"/> OVC III
	<input type="checkbox"/> OVC I	<input checked="" type="checkbox"/> OVC II	<input type="checkbox"/> OVC III
Over voltage category DC :	<input type="checkbox"/> OVC I	<input checked="" type="checkbox"/> OVC II	<input type="checkbox"/> OVC III
Mains supply tolerance (%)	-90 / +110 %		
Tested for power systems	TN systems		
IT testing, phase-phase voltage (V)	- - -		
Class of equipment :	<input checked="" type="checkbox"/> Class I	<input type="checkbox"/> Class II	<input type="checkbox"/> Class III
	<input type="checkbox"/> Not classified		
Mass of equipment (kg) :	Approx. 25Kg		
Pollution degree	Outside PD3; Inside PD2		
IP protection class	IP 65		
..... :			
Possible test case verdicts:			
- test case does not apply to the test object: N/A			
- test object does meet the requirement.....: P (Pass)			
- test object was not evaluated for the requirement.....: N/E			
- test object does not meet the requirement: F (Fail)			
Testing			
Date of receipt of test item: 15 Oct 2020			
Date (s) of performance of tests			
15 Oct 2020 – 21 Nov 2020			

General remarks:	
"(See Enclosure #)" refers to additional information appended to the report. "(See appended table)" refers to a table appended to the report.	
Throughout this report a <input type="checkbox"/> comma / <input checked="" type="checkbox"/> point is used as the decimal separator.	
This report shall be used together with report No.201015063GZU-002	
Manufacturer's Declaration per sub-clause 4.2.5 of IEC60900:	
The application for obtaining a CB Test Certificate includes more than one factory location and a declaration from the Manufacturer stating that the sample(s) submitted for evaluation is (are) representative of the products from each factory has been provided..... :	<input type="checkbox"/> Yes <input checked="" type="checkbox"/> Not applicable
When differences exist; they shall be identified in the General product information section.	
Name and address of factory (ies) : Dongguan SOFAR SOLAR Co., Ltd. 1F-6F, Building E, No.1 JinQi Road, Bihu Industrial Park, Wulian Village, Fenggang Town, Dongguan City	

General product information:

The unit is a single-phase hybrid inverter, it can convert the high PV voltage and Grid voltage to low DC for charge battery, also convert PV voltage and battery voltage to AC Grid.

The unit is providing EMI filtering at the PV and battery side. It does provide galvanic separation from PV side to Grid. The battery circuit does provide high frequency isolation to PV side and AC mains.

The unit has two controllers. The master DSP controller monitors the charge or discharge status; measures the PV voltage and current, battery current, bus voltage, AC voltage, current, GFCI and frequency.

The slave DSP controller monitors AC voltage, current, frequency, GFCI and communicates with the master controller.

The master DSP and slave DSP are used together to control relay open or close. If there is a single fault on one DSP, the other DSP can be capable of opening the relay, so that it still provides safety means.

The topology diagram is as follows:

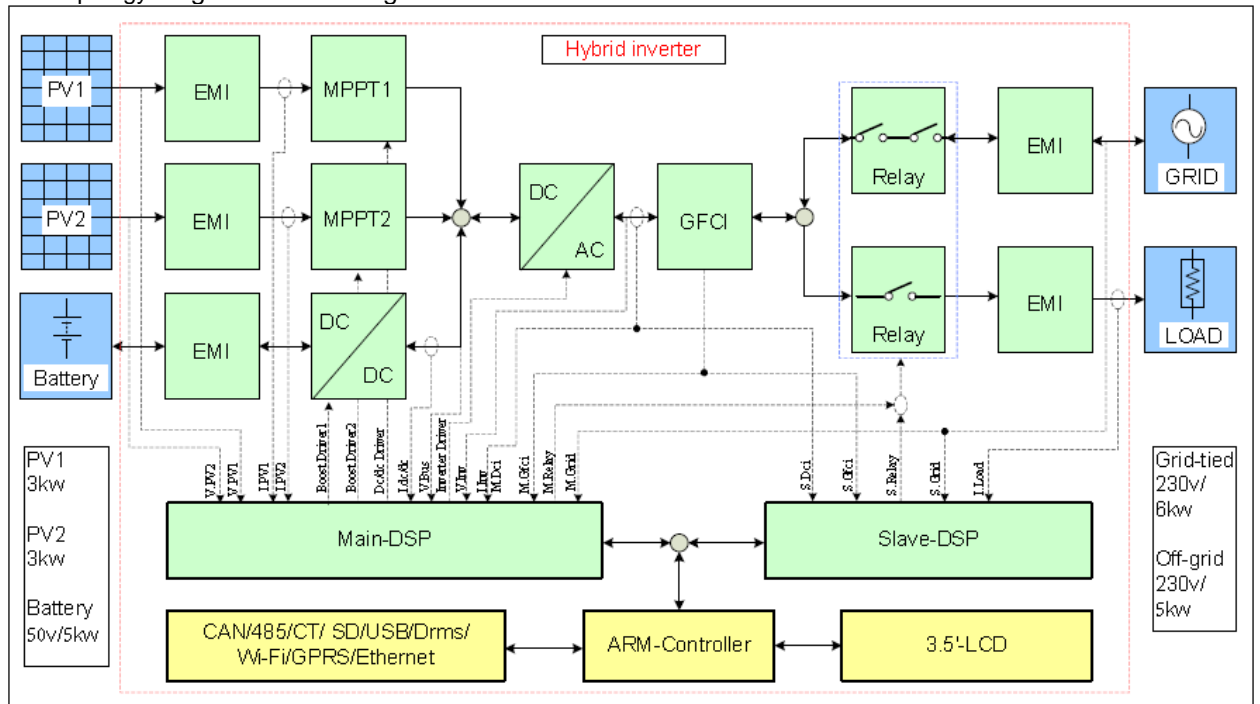

Model differences:

The models HYD 6000-EP, HYD 5500-EP, HYD 5000-EP, HYD 4600-EP, HYD 4000-EP, HYD 3680-EP, HYD 3000-EP are identical and only the output power derating in software. except for the following table.

Model	HYD 6000-EP	HYD 5500-EP	HYD 5000-EP	HYD 4600-EP	HYD 4000-EP	HYD 3680-EP	HYD 3000-EP
R332, R334, R336	0Ω, NC, 0Ω			NC, 0Ω, NC			
Bus capacitance	8pcs			6pcs			
INV inductor	0.75mH			1.035mH			
R123, R132	1.5KΩ, 1.5KΩ			499Ω, 499Ω			

The product was tested on:

The Software version: V02000

The Hardware version: V001



Other than special notes, typical model HYD 6000-EP used as representative for testing in this report.

Rating:							
Model	HYD 3000-EP	HYD 3680-EP	HYD 4000-EP	HYD 4600-EP	HYD 5000-EP	HYD 5500-EP	HYD 6000-EP
Max. PV Input Voltage [d.c.V]	600						
MPPT operating voltage range [d.c.V]	90-580						
Number of MPP trackers	2						
Max. input current per MPPT [d.c.A]	13/13						
Max. PV Isc [d.c.A]	2 X 18						
Battery Type	Lead-acid, Lithium-ion						
Battery Voltage Range [d.c.V]	42-58						
Max. Charging Current [d.c.A]	75	80	85	100	100	100	100
Max. Discharging Current [d.c.A]	75	80	85	100	100	100	100
Max. Charging & Discharging Power [W]	3750	4000	4250	5000	5000	5000	5000
Nominal Grid voltage [a.c.V]	230						
Nominal Output Voltage (backup) [a.c.V]	230						
Max. output current [a.c.A]	15	16	20	20.9	21.7	25	27.3

Max AC current from utility grid [a.c.A]	27.3	32	36.4	41.8	43.4	43.4	54.6
Nominal Grid Frequency	50/60Hz						
Power Factor	1 (adjustable +/-0.8)						
Nominal AC power [W]	3000	3680	4000	4600	5000	5000	6000
Backup Max.current [a.c.A]	13.6	16.0	18.2	20.9	22.7	22.7	22.7
Backup Max. Apparent Power [VA]	3000	3680	4000	4600	5000	5000	5000
Ingress Protection	IP 65						
Protective Class	Class I						
Operating temperature range	-30 ~ +60°C						

IEC 62109-1			
Clause	Requirement – Test	Result – Remark	Verdict
4	GENERAL TESTING REQUIREMENTS		P
4.1	General		P
4.2	General conditions for testing		P
4.2.1	Sequence of tests		P
4.2.2	Reference test conditions		P
4.2.2.1	Environmental conditions	Max. 60°C rated ambient temperature tested.	P
4.2.2.2	State of equipment		P
4.2.2.3	Position of equipment	Be fixed in accordance with the manufacturer's instruction	P
4.2.2.4	Accessories		N/A
4.2.2.5	Covers and removable parts		N/A
4.2.2.6	Mains supply a) Voltage: b) Frequency: c) Polarity: d) Earthing: e) Over-current Protection:	(see appended table 4.2.2.6)	P
4.2.2.7	Supply ports other than the mains		P
4.2.2.7.1	Photovoltaic supply sources a) Open circuit voltage: b) Short-circuit current:	(see appended table 4.2.2.7)	P
4.2.2.7.2	Battery inputs		P
4.2.2.8	Conditions of loading for output ports		P
4.2.2.9	Earthing terminals		P
4.2.2.10	Controls		N/A
4.2.2.11	Available short circuit current		P
4.3	Thermal testing	(see appended table 4.3)	P
4.3.1	General		P
4.3.2	Maximum temperatures		P
4.3.2.1	General		P
4.3.2.2	Touch temperatures		P
4.3.2.3	Temperature limits for mounting surfaces		P
4.4	Testing in single fault condition	(see appended table 4.4)	P
4.4.1	General		P
4.4.2	Test conditions and duration for testing under fault conditions		P

IEC 62109-1			
Clause	Requirement – Test	Result – Remark	Verdict
4.4.2.1	General		P
4.4.2.2	Duration of tests		P
4.4.3	Pass/fail criteria for testing under fault conditions		P
4.4.3.1	Protection against shock hazard		P
4.4.3.2	Protection against the spread of fire		P
4.4.3.3	Protection against other hazards		P
4.4.3.4	Protection against parts expulsion hazards		P
4.4.4	Single fault conditions to be applied	(See appended tables)	P
4.4.4.1	Component fault tests		P
4.4.4.2	Equipment or parts for short-term or intermittent operation	Not for short-term or intermittent operation	N/A
4.4.4.3	Motors	For fan inside	P
4.4.4.4	Transformer short circuit tests		P
4.4.4.5	Output short circuit		P
4.4.4.6	Backfeed current test for equipment with more than one source of supply	Considered	P
4.4.4.7	Output overload		P
4.4.4.8	Cooling system failure	Blanketing test for the heatsink according to IEC 62109-2 Clause 4.4.4.17	P
4.4.4.9	Heating devices	No heating devices	N/A
4.4.4.10	Safety interlock systems	No safety interlock	N/A
4.4.4.11	Reverse d.c. connections	Reverse DC+ and DC-, the PCE can't start-up. No damaged.	P
4.4.4.12	Voltage selector mismatch	No voltage selector	N/A
4.4.4.13	Mis-wiring with incorrect phase sequence or polarity	Mis-wiring: L to N, normal operation	P
4.4.4.14	Printed wiring board short-circuit test		P
4.5	Humidity preconditioning	(see appended table 7.5)	P
4.5.1	General		P
4.5.2	Conditions	95% R.H. 40°C. 48H	P
4.6	Backfeed voltage protection		P
4.6.1	Backfeed tests under normal conditions	The max. DC input and output are less than 60V, disconnected DC inputs and main	P
4.6.2	Backfeed tests under single-fault conditions	PV input is separated from Main with basic insulation under normal and single-fault	P

IEC 62109-1			
Clause	Requirement – Test	Result – Remark	Verdict
		conditions with disconnection method evaluated to IEC 62109-2 Also,    is presented on the marking label means that “After disconnect must wait for 5 mins can touch with PCE terminal”	
4.6.3	Compliance with backfeed tests		P
4.7	Electrical ratings tests	(see appended table 4.2.2.6)	P
4.7.1	Input ratings		P
4.7.1.1	Measurement requirements for DC input ports		P
4.7.2	Output ratings		P

5	MARKING AND DOCUMENTATION		P
5.1	Marking		P
5.1.1	General		P
	Equipment shall bear markings as specified in 5.1 and 5.2	Label are marked on PCE and graphic symbol is explained in user manual	P
	Graphic symbols may be used and shall be in accordance with Annex C or IEC 60417 as applicable.		P
	Graphic symbols shall be explained in the documentation provided with the PCE.		P
5.1.2	Durability of markings		P
	Markings required by this clause to be located on the PCE shall remain clear and legible under conditions of NORMAL USE and resist the effects of cleaning agents specified by the manufacturer	After this test, the markings are clearly legible. There was neither loose nor curling on the edge of label.	P
5.1.3	Identification		P
	The equipment shall, as a minimum, be permanently marked with:		P
	a) the name or trade mark of the manufacturer or supplier	Trade mark: SOFAR SOLAR	P
	b) model number, name or other means to identify the equipment		P
	c) a serial number, code or other marking allowing identification of manufacturing location and the manufacturing batch or date within a three month time period.	Within three month	P

IEC 62109-1			
Clause	Requirement – Test	Result – Remark	Verdict
5.1.4	Equipment ratings	See below	P
	Unless otherwise specified in another part of IEC 62109, the following ratings, as applicable shall be marked on the equipment:		P
	– input voltage, type of voltage (a.c. or d.c.), frequency, and max. continuous current for each input	Refer to the marking label	P
	– output voltage, type of voltage (a.c. or d.c.), frequency, max. continuous current, and for a.c. outputs, either the power or power factor for each output	Refer to the marking label	P
	– the ingress protection (IP) rating as in 6.3 below	IP 65	P
5.1.5	Fuse identification	See below	P
	Marking shall be located adjacent to each fuse or fuseholder, or on the fuseholder, or in another location provided that it is obvious to which fuse the marking applies, giving the fuse current rating and where fuses of different voltage rating value could be fitted, the fuse voltage rating.		N/A
	Where fuses with special fusing characteristics such as time delay or breaking capacity are necessary, the type shall also be indicated		N/A
	For fuses not located in operator access areas and for soldered-in fuses located in operator access areas, it is permitted to provide an unambiguous cross-reference (for example, F1, F2, etc.) to the servicing instructions which shall contain the relevant information.	The fuse rating marked on The circuit diagram and Maintenance manual.	P
5.1.6	Terminals, Connections, and Controls		P
	If necessary for safety, an indication shall be given of the purpose of Terminals, connectors, controls, and indicators, and their various positions, including any connections for coolant fluids such as water and drainage. The symbols in Annex C may be used, and where there is insufficient space, symbol 9 of Annex C may be used.	The indications were provided adjacent to Battery terminals, AC and DC quick Connector.	P
	Push-buttons and actuators of emergency stop devices, and indicator lamps used only to indicate a warning of danger or the need for urgent action shall be coloured red.		P
	A multiple-voltage unit shall be marked to indicate the particular voltage for which it is set when shipped from the factory. The marking is allowed to be in the form of a paper tag or any other non-permanent material.	The PCE is not intended to connect to multiple-voltage and there is no voltage setting device.	N/A
	A unit with d.c. terminals shall be plainly marked indicating the polarity of the connections, with:	The “+” and “-” marking were provided adjacent to the DC input terminals and battery	P

IEC 62109-1			
Clause	Requirement – Test	Result – Remark	Verdict
		terminals.	
	– the sign “+” for positive and “-”, for negative; or		
	– a pictorial representation illustrating the proper polarity where the correct polarity can be unambiguously determined from the representation	Not provided	N/A
5.1.6.1	Protective Conductor Terminals		P
	The means of connection for the protective earthing conductor shall be marked with:		P
	– symbol 7 of Annex C; or		P
	– the letters “PE”; or		N/A
	– the colour coding green-yellow.		P
5.1.7	Switches and circuit-breakers	Approved switch was used for all models.	P
	The on and off-positions of switches and circuits breakers shall be clearly marked. If a push-button switch is used as the power switch, symbols 10 and 16 of Annex C may be used to indicate the on-position, or symbols 11 and 17 to indicate the off-position, with the pair of symbols (10 and 16, or 11 and 17) close together.	“ON” indicated the on-position of DC switch. “OFF” indicated the off-position of DC switch	P
5.1.8	Class II Equipment	Class I	N/A
	Equipment using Class II protective means throughout shall be marked with symbol 12 of Annex C. Equipment which is only partially protected by DOUBLE INSULATION or REINFORCED INSULATION shall not bear symbol 12 of Table Annex C.		N/A
	Where such equipment has provision for the connection of an earthing conductor for functional reasons (see 7.3.6.4) it shall be marked with symbol 6 of Annex C		N/A
5.1.9	Terminal boxes for External Connections	No such parts	N/A
	Where required by note 1 of Table 2 as a result of high temperatures of terminals or parts in the wiring compartment, there shall be a marking, visible beside the terminal before connection, of either:		N/A
	a) the minimum temperature Rating and size of the cable to be connected to the TERMINALS; or		N/A
	b) a marking to warn the installer to consult the installation instruction. Symbol 9 of Table D-1 is an acceptable marking		N/A
5.2	Warning markings		P

IEC 62109-1			
Clause	Requirement – Test	Result – Remark	Verdict
5.2.1	Visibility and legibility requirements for warning markings		P
	Warning markings shall be legible, and shall have minimum dimensions as follows:		P
	– Printed symbols shall be at least 2,75 mm high		P
	– Printed text characters shall be at least 1.5 mm high and shall contrast in colour with the background		P
	– Symbols or text that are moulded, stamped or engraved in a material shall have a character height of at least 2,0 mm, and if not contrasting in colour from the background, shall have a depth or raised height of at least 0,5 mm.		P
	If it is necessary to refer to the instruction manual to preserve the protection afforded by the equipment, the equipment shall be marked with symbol 9 of Annex C	The manual provides necessary information for warning marking	P
	Symbol 9 of Annex C is not required to be used adjacent to symbols that are explained in the manual		P
5.2.2	Content for warning markings		P
5.2.2.1	Ungrounded heat sinks and similar parts	Grounded heatsink and metal enclosure	N/A
	An ungrounded heat sink or other part that may be mistaken for a grounded part and involves a risk of electric shock in accordance with 7.3 shall be marked with symbol 13 of Annex C, or equivalent. The marking may be on or adjacent to the heat sink and shall be clearly visible when the PCE is disassembled to the extent that a risk of contact with the heat sink exists.		N/A
5.2.2.2	Hot Surfaces		P
	A part of the PCE that exceeds the temperature limits specified in 4.3.2 shall be marked with symbol 14 of Annex C or equivalent.	The symbol 14 of Annex C provided on the warning label which located on the surface of enclosure	P
5.2.2.3	Coolant	Coolant is not used	N/A
	A unit containing coolant that exceeds 70 °C shall be legibly marked externally where readily visible after installation with symbol 15 of Annex C. The documentation shall provide a warning regarding the risk of burns from hot coolant, and either:		N/A
	a) statement that coolant system servicing is to be done only by SERVICE PERSONNEL, or		N/A
	b) instructions for safe venting, draining, or otherwise working on the cooling system, if		N/A

IEC 62109-1			
Clause	Requirement – Test	Result – Remark	Verdict
	these operations can be performed without OPERATOR access to HAZARDS internal to the equipment		
5.2.2.4	Stored energy		P
	Where required by 7.3.9.2 or 7.4.2 the PCE shall be marked with Symbol 21 of Annex C and the time to discharge capacitors to safe voltage and energy levels shall accompany the symbol.		P
5.2.2.5	Motor guarding	Fan inside the enclosure	N/A
	Where required by 8.2 a marking shall be provided where it is visible to service personnel before removal of a guard, warning of the hazard and giving instructions for safe servicing (for example disconnection of the source before removing the guard).		N/A
5.2.3	Sonic hazard markings and instructions	Hazardous noise is not produced	N/A
	If required by 10.2.1 a PCE shall:		N/A
	a) be marked to warn the operator of the sonic pressure hazard; or		N/A
	b) be provided with installation instructions that specify how the installer can ensure that the sound pressure level from equipment at its point of use after installation, will not reach a value, which could cause a hazard. These instructions shall include the measured sound pressure level, and shall identify readily available and practicable protective materials or measures which may be used.		N/A
5.2.4	Equipment with multiple sources of supply		P
	A PCE with connections for multiple energy sources shall be marked with symbol 13 of Annex C and the manual shall contain the information required in 5.3.4.	Marked with symbol 13 of Annex C and explained in user manual.	P
	The symbol shall be located on the outside of the unit or shall be prominently visible behind any cover giving access to hazardous parts.		P
5.2.5	Excessive touch current		N/A
	Where required by 7.3.6.3.7 the PCE shall be marked with symbol 15 of Annex C. See also 5.3.2 for information to be provided in the installation manual.	The touch current does not exceed limited	N/A
5.3	Documentation		P
5.3.1	General		P
	The documentation provided with the PCE shall provide the information needed for the safe		P

IEC 62109-1			
Clause	Requirement – Test	Result – Remark	Verdict
	operation, installation, and (where applicable) maintenance of the equipment. The documentation shall include the items required in 5.3.2 through 5.3.4, and the following:		
	a) explanations of equipment makings, including symbols used		P
	b) location and function of terminals and controls		P
	c) all ratings or specifications that are necessary to safely install and operate the PCE, including the following environmental ratings along with an explanation of their meaning and any resulting installation requirements:		P
	– ENVIRONMENTAL CATEGORY as per 6.1	Outdoor	P
	– WET LOCATIONS classification for the intended external environment as per 6.1	Suitable for wet location	P
	– POLLUTION DEGREE classification for the intended external environment as per 6.2	Outside: PD3, Inside: PD2	P
	– INGRESS PROTECTION rating as per 6.3	IP 65	P
	– Ambient temperature and relative humidity ratings	Max. +60°C and 100% R.H.	P
	– MAXIMUM altitude rating	2000m	P
	– OVERVOLTAGE CATEGORY assigned to each input and output port as per 7.3.7.1.2, accompanied by guidance regarding how to ensure that the installation complies with the required overvoltage categories;	OVC II(PV and battery side), OVC III(Mains)	P
	d) a warning that when the photovoltaic array is exposed to light, it supplies a d.c. voltage to the PCE		P
5.3.1.1	Language	English provide	P
	Instructions related to safety shall be in a language that is acceptable in the country where the equipment is to be installed.	For other country language further evaluated is needed	N/A
5.3.1.2	Format		P
	In general, the documentation must be provided in printed form and is to be delivered with the equipment.	Printed form provided	P
	For equipment which requires the use of a computer for both installation and operation, documentation may be provided in electronic format without accompanying printed format.		N/A
5.3.2	Information related to installation		P
	The documentation shall include installation and where applicable, specific commissioning		P

IEC 62109-1			
Clause	Requirement – Test	Result – Remark	Verdict
	instructions and, if necessary for safety, warnings against hazards which could arise during installation or commissioning of the equipment. The information provided shall include:		
	a) assembly, location, and mounting requirements;		P
	b) ratings and means of connection to each source of supply and any requirements related to wiring and external controls, colour coding of leads, disconnection means, or overcurrent protection needed, including instructions that the installation position shall not prevent access to the disconnection means;		P
	c) ratings and means of connection of any outputs from the PCE, and any requirements related to wiring and external controls, colour coding of leads, or overcurrent protection needed;		P
	d) explanation of the pin-out of connectors for external connections, unless the connector is used for a standard purpose (e.g. RS 232)		P
	e) ventilation requirements;		P
	f) requirements for special services, for example cooling liquid;		N/A
	g) instructions and information relating to sound pressure level if required by 10.2.1;		N/A
	h) where required by 14.8.1.3, instructions for the adequate ventilation of the room or location in which PCE containing vented or valve-regulated batteries is located, to prevent the accumulation of hazardous gases;	Sealed lead acid battery and lithium battery of external battery pack (EBP) used. The detail installation and maintenance explanations are provided in the manufacturer's EBP of manual	P
	i) tightening torque to be applied to wiring terminals;		N/A
	j) values of backfeed short-circuit currents available from the PCE on input and output conductors under fault conditions, if those currents exceed the max. rated current of the circuit, as per 4.4.4.6;	The backfeed current Was prevented.	N/A
	k) for each input to the PCE, the max value of short-circuit current available from the source, for which the PCE is designed; and		P
	l) compatibility with RCD and RCM;	Internal RCM is used	N/A
	m) instructions for protective earthing, including the information required by 7.3.6.3.7 if a second protective earthing conductor is to be installed:	Touch current is not exceeded limit	N/A
	n) where required by 7.3.8, the installation		N/A

IEC 62109-1			
Clause	Requirement – Test	Result – Remark	Verdict
	instructions shall include the following or equivalent wording:		
	“This product can cause a d.c. current in the external protective earthing conductor. Where a residual current-operated protective (RCD) or monitoring (RCM) device is used for protection in a case of direct or indirect contact, only an RCD or RCM of Type B is allowed on the supply side of this product.”	Internal RCM is used	N/A
	o) for PCE intended to charge batteries, the battery nominal voltage rating, size, and type	The explanations are provided in the manual.	P
	p) PV array configuration information, such as ratings, whether the array is to be grounded or floating, any external protection devices needed, etc.	PV array should be floating configuration to be connected to PCE, relevant information had shown on the installation manual.	P
5.3.3	Information related to operation		P
	Instructions for use shall include any operating instructions necessary to ensure safe operation, including the following, as applicable:		P
	– Instructions for adjustment of controls including the effects of adjustment;		P
	– Instructions for interconnection to accessories and other equipment, including indication of suitable accessories, detachable parts and any special materials;		P
	– Warnings regarding the risk of burns from surfaces permitted to exceed the temperature limits of 4.3.2 and required operator actions to reduce the risk; and		P
	– Instructions, that if the equipment is used in a manner not specified by the manufacturer, the protection provided by the equipment may be impaired.		P
5.3.4	Information related to maintenance		P
	Maintenance instructions shall include the following:		P
	– Intervals and instructions for any preventive maintenance that is required to maintain safety (for example air filter replacement or periodic re-tightening of terminals);		P
	– Instructions for accessing operator access areas, if any are present, including a warning not to enter other areas of the equipment;	No such part	P
	– Part numbers and instructions for obtaining any required operator replaceable parts;		N/A

IEC 62109-1			
Clause	Requirement – Test	Result – Remark	Verdict
	– Instructions for safe cleaning (if recommended)		N/A
	– Where there is more than one source of supply energizing the PCE, information shall be provided in the manual to indicate which disconnect device or devices are required to be operated in order to completely isolate the equipment.		P
5.3.4.1	Battery maintenance	External battery module used, and should evaluate in the final product.	P
	Where required by 14.8.5, the documentation shall include the applicable items from the following list of instructions regarding maintenance of batteries:		P
	– Servicing of batteries should be performed or supervised by personnel knowledgeable about batteries and the required precautions		P
	– When replacing batteries, replace with the same type and number of batteries or battery packs	The detail installation and maintenance explanations are provided in the manufacturer's EBP of manual.	N/A
	– General instructions regarding removal and installation of batteries		N/A
	– CAUTION: Do not dispose of batteries in a fire. The batteries may explode.		N/A
	– CAUTION: Do not open or damage batteries. Released electrolyte is harmful to the skin and eyes. It may be toxic.		N/A
	– CAUTION: A battery can present a risk of electrical shock and high short-circuit current. The following precautions should be observed when working on batteries:		N/A
	a) Remove watches, rings, or other metal objects.		N/A
	b) Use tools with insulated handles.		N/A
	c) Wear rubber gloves and boots.		N/A
	d) Do not lay tools or metal parts on top of batteries		N/A
	e) Disconnect charging source prior to connecting or disconnecting battery terminals		N/A
	f) Determine if battery is inadvertently grounded. If inadvertently grounded, remove source from ground. Contact with any part of a grounded battery can result in electrical shock. The likelihood of such shock can be reduced if such grounds are removed during installation and maintenance (applicable to equipment and remote battery supplies not having a grounded supply circuit).		N/A

IEC 62109-1			
Clause	Requirement – Test	Result – Remark	Verdict
6	ENVIRONMENTAL REQUIREMENTS AND CONDITIONS		P
	The manufacturer shall rate the PCE for the following environmental conditions:		P
	– ENVIRONMENTAL CATEGORY, as in 6.1 below	Outdoor used	P
	– Suitability for WET LOCATIONS or not	Yes	P
	– POLLUTION DEGREE rating in 6.2 below	Outside PD3, Inside PD2	P
	– INGRESS PROTECTION (IP) rating, as in 6.3 below	IP 65	P
	– Ultraviolet (UV) exposure rating, as in 6.4 below		P
	– Ambient temperature and relative humidity ratings, as in 6.5 below	Max. 60°C, 100%R.H.	P
6.1	Environmental categories and minimum environmental conditions		P
6.1.1	Outdoor		P
6.1.2	Indoor, unconditioned		N/A
6.1.3	Indoor, conditioned		N/A
6.2	Pollution degree	PD3	P
6.3	Ingress Protection	IP65	P
6.4	UV exposure		P
6.5	Temperature and humidity	-30°C~+60°C, 0%~100% R.H.	P
7	PROTECTION AGAINST ELECTRIC SHOCK AND ENERGY HAZARDS		P
7.1	General		P
7.2	Fault conditions	Normal and single fault condition are considered	P
7.3	Protection against electric shock		P
7.3.1	General	In the PCE the earthed metal enclosure is evaluated by means of basic insulation from DVC C circuit DVC A circuit and unearthed accessible parts are evaluated by means of reinforced insulation from DVC C or protective impedance DVC C circuit: The PV, battery input and the Main output DVC A circuit: The signal communication output port.	P
7.3.2	Decisive voltage classification		P
7.3.2.1	Use of decisive voltage class (DVC)	Working voltage and protective measure and considered	P

IEC 62109-1			
Clause	Requirement – Test	Result – Remark	Verdict
7.3.2.2	Limits of DVC (according table 6)	Wet location is considered for PCE outside only	P
7.3.2.3	Short-terms limits of accessible voltages under fault conditions		P
7.3.2.4	Requirements for protection (according table 7)	Single fault condition is considered	P
7.3.2.5	Connection to PELV and SELV circuits	The external signal communication port is considered as SELV	P
7.3.2.6	Working voltage and DVC		P
7.3.2.6.1	General	Transients and voltage fluctuation are disregarded. And worst-case normal operation condition is considered	P
7.3.2.6.2	AC working voltage (see Figure 2)		P
7.3.2.6.3	DC working voltage (see Figure 3)		P
7.3.2.6.4	Pulsating working voltage (see Figure 4)		P
7.3.3	protective separation	In the PCE the earthed metal enclosure is evaluated by means of basic insulation from DVC C circuit DVC A circuit and unearthed accessible parts are evaluated by means of reinforced insulation from DVC C or protective impedance DVC C circuit: The PV input and the Main output DVC A circuit: The signal communication output port	P
	Protective separation shall be achieved by:		P
	<ul style="list-style-type: none"> ▪ double or reinforced insulation, or 	The double or reinforced insulation was provided between 1) DC input circuits and communication circuits; 2) Battery circuits and communication circuits; 3) AC output circuits and communication circuits.	P
	<ul style="list-style-type: none"> ▪ protective screening, i.e. by a conductive screen connected to earth by protective bonding in the PCE, or connected to the protective earth conductor itself, whereby the screen is separated from live parts by at least basic insulation, or 		P
	<ul style="list-style-type: none"> ▪ protective impedance comprising limitation of current per 7.3.5.3 and of discharged energy 		P

IEC 62109-1			
Clause	Requirement – Test	Result – Remark	Verdict
	per 7.3.5.4, or		
	▪ limitation of voltage according to 7.3.5.4.		N/A
	The protective separation shall be fully and effectively maintained under all conditions of intended use of the PCE		P
7.3.4	Protection against direct contact		P
7.3.4.1	General		P
	Protection against direct contact is employed to prevent persons from touching live parts that do not meet the requirements of 7.3.5 and shall be provided by one or more of the measure given in 7.3.4.2 (enclosures and barriers) and 7.3.4.3 (insulation).	Metal enclosure provided	P
	Open type sub-assemblies and devices do not require protective measures against direct contact but the instruction provided with the equipment must indicate that such measures must be provided in the end equipment or in the installation.		N/A
	Product intended for installation in CLOSED ELECTRICAL OPERATING AREAS, (see 3.9) need not have protective measures against direct contact, except as required by 7.3.4.2.4.	Not use under this condition	N/A
7.3.4.2	Protection by means of enclosures and barriers		P
	The following requirements apply where protection against contact with live parts is provided by enclosures or barriers, not by insulation in accordance with 7.3.4.3.	Enclosure provided to prevent access to inside live parts	P
7.3.4.2.1	General		P
	Parts of enclosures and barriers that provide protection in accordance with these requirements shall not be removable without the use of a tool (see 7.3.4.2.3).	Secured by screws	P
	Polymeric materials used to meet these requirements shall also meet the requirements of 13.6	The plastic material used on display screen is evaluated via clause 13.6	P
7.3.4.2.2	Access probe criteria		P
	Protection is considered to be achieved when the separation between the test probes and live parts, when tested as described below, is as follows:		P
	a) decisive voltage classification A, (DVC A) - the probe may touch the live parts	The signal is considered as DVC A	P
	b) decisive voltage classification B, (DVC B) - the probe must not touch bare live parts	The DVC B circuit is not accessible by probe	P
	c) decisive voltage classification C, (DVC C) – the probe must have adequate clearance to live	The DVC C circuit is not accessible by probe	P

IEC 62109-1			
Clause	Requirement – Test	Result – Remark	Verdict
	parts, based on the clearance for Basic insulation using the recurring peak working voltage involved,		
7.3.4.2.3	Access probe tests		P
	Compliance with 7.3.4.2.1 is checked by all of the following:		P
	a) Inspection; and		P
	b) Tests with the test finger (Figure D.1) and test pin (Figure D.2) of 0E, the results of which shall comply with the requirements of 7.3.4.2.1 a), b), and c) as applicable. Probe tests are performed on openings in the enclosures after removal of parts that can be detached or opened by an operator without the use of a tool, including fuseholders, and with operator access doors and covers open. It is permitted to leave lamps in place for this test. Connectors that can be separated by an operator without use of a tool, shall also be tested during and after disconnection. Any movable parts are to be put in the most unfavourable position.		P
	The test finger and the test pin are applied as above, without appreciable force, in every possible position, except that floor-standing equipment having a mass exceeding 40 kg is not tilted.		P
	Equipment intended for building-in or rack mounting, or for incorporation in larger equipment, is tested with access to the equipment limited according to the method of mounting detailed in the installation instructions.		N/A
	c) Openings preventing the entry of the jointed test finger (Figure E-1 of 0E) during test b) above, are further tested by means of straight unjointed test finger (Figure E-3 of 0E), applied with a force of 30 N. If the unjointed finger enters, the test with the jointed finger is repeated except that the finger is applied using any necessary force up to 30 N.	No openings	N/A
	d) In addition to a) – c) above, top surfaces of enclosure shall be tested with the IP3X probe of IEC 60529. The test probe shall not penetrate the top surface of the enclosure when probed from the vertical direction $\pm 5^\circ$ only.	Metal enclosure	N/A
7.3.4.2.4	Service access areas	Inside PCE are not intentionally touched with energized part when installation and maintenance. Symbol 21 of Annex C are	P

IEC 62109-1			
Clause	Requirement – Test	Result – Remark	Verdict
		marked on PCE and explained in user manual	
7.3.4.3	Protection by means of insulation of live parts	The earthed enclosure is with basic insulation from the live parts inside	N/A
	Where the requirements of 7.3.4.2 are not met, live parts shall be provided with insulation if:		N/A
	– their working voltage is greater than the maximum limit of decisive voltage class A, or		N/A
	– for a DVC A or B circuit, protective separation from adjacent circuit of DVC C is not provided (see note “†” under Table 7)		N/A
7.3.5	Protection in case of direct contact	The single communication port is direct contact and evaluated with reinforced insulation from live part	P
7.3.5.1	General		P
	Protection in case of direct contact is required to ensure that contact with live parts does not produce a shock hazard.		P
	The protection against direct contact according to 7.3.4 is not required if the circuit contacted is separated from other circuits according to 7.3.2.3, and:	Considered	P
	– is of decisive voltage class A and complies with 7.3.5.2, or	The single communication port is DVC A and reinforced insulation from the live part by means of isolation transformer and optocoupler	P
	– is provided with protective impedance according to 7.3.5.3, or		N/A
	– is limited in voltage according to 7.3.5.4		N/A
	In addition to the measures as given in 7.3.5.2 to 7.3.5.4, it shall be ensured that in the event of error or polarity reversal of connectors no voltages that exceed DVC A can be connected into a circuit with protective separation. This applies for example to plug-in-sub-assemblies or other plug-in devices which can be plugged-in without the use of a tool (key) or which are accessible without the use of a tool.	Considered	P
	Conformity is checked by visual inspection and trial insertion.		P
7.3.5.2	Protection using decisive voltage class A	The communication port is DVC A and reinforced insulation from the live part by means of isolation transformer	P

IEC 62109-1			
Clause	Requirement – Test	Result – Remark	Verdict
		and optocoupler	
7.3.5.3	Protection by means of protective impedance	Protective impedance not used as protective separation in the PCE	N/A
	Circuits and conductive parts do not require protection against direct contact if any connection to circuits of DVC-B or DVC-C is through protective impedance, and the accessible circuit or part is otherwise provided with protective separation from circuits of DVC-B or DVC-C according 7.3.3.		N/A
7.3.5.3.1	Limitation of current through protective impedance		N/A
	The current available through protective impedance to earth and between simultaneously accessible parts, measured at the accessible live parts, shall not exceed a value of 3,5 mA a.c. or 10 mA d.c. under normal and single-fault conditions.		N/A
7.3.5.3.2	Limitation of discharging energy through protective impedance		N/A
	The discharging energy available between simultaneously accessible parts protected by protective impedance shall not exceed the charging voltage and capacitance limits given in Table 9, which applies to both wet and dry locations, under normal and single fault conditions. Refer to figure 8.		N/A
7.3.5.4	Protection by means of limited voltages	No such design	N/A
	That portion of a circuit that has its voltage reduced to DVC-A by a voltage divider that complies with the following requirements, and that is otherwise provided with protective separation from circuits of DVC-B or DVC-C according to 7.3.3, does not require protection against direct contact.		N/A
	The voltage divider shall be designed so that under normal and single fault conditions, including faults in the voltage division circuit, the voltage across the output of the voltage divider does not exceed the limit for DVC-A.		N/A
	This type of protection shall not be used in case of protective class II or unearthed circuits, because it relies on protective earth being connected.		N/A
7.3.6	Protection against indirect contact		P
7.3.6.1	General		P
	Protection against indirect contact is required to prevent shock- hazardous current being accessible from conductive parts during an insulation failure. This protection shall comply with the requirements for protective class I (basic insulation plus protective earthing), class II (double or reinforced insulation) or class III (limitation of voltages)	The earthing metal enclosure is complied with protective class I and the circuit of communication is complied with protective class II for accessible communication	P

IEC 62109-1			
Clause	Requirement – Test	Result – Remark	Verdict
		ports.	
	That part of a PCE meets the requirements of 7.3.6.2 and 7.3.6.3 is defined as protective class I	The earthed metal enclosure meets this requirement	P
	That part of a PCE meets the requirements of 7.3.6.4 is defined as protective class II.		N/A
	That part of PCE which meets the requirements of decisive voltage class A and in which no hazardous voltages are derived, is defined as protective class III. No shock hazard is present in such circuits.		N/A
	Where protection against indirect contact is dependent on means provided during installation, the installation instructions shall provide details of the required means and shall indicate the associated hazards.	The manual requires the PCE must be securely earthed	P
7.3.6.2	Insulation between live parts and accessible conductive parts		P
	Accessible conductive parts of equipment shall be separated from live parts by insulation meeting the requirements of Table 7 or by clearances as specified in 7.3.7.4 and creepages as specified in 7.3.7.5	See Cl. 7.3.7.4 and Cl. 7.3.7.5	P
7.3.6.3	Protective class I – Protective bonding and earthing		P
7.3.6.3.1	General		P
	Equipment of protective class I shall be provided with protective earthing, and with protective bonding to ensure electrical contact between accessible conductive parts and the means of connection for the external protective earthing conductor, except bonding is not required for:		P
	a) accessible conductive parts that are protected by one of the measures in 7.3.5.2 to 7.3.5.4, or		P
	b) accessible conductive parts are separated from live parts of DVC-B or -C using double or reinforced insulation.	Communication circuits are separated from live parts used double or reinforced insulation	P
7.3.6.3.2	Requirements for protective bonding		P
	Electrical contact with the means of connection of the external protective earthing conductor shall be achieved by one or more of the following means:		P
	a) through direct metallic contact;	The connection of external protective earthing conductor is direct metal contact via a terminal with screw.	P
	b) through other conductive parts which are not removed when the PCE or sub-units are used as intended ;		N/A
	c) through a dedicated protective bonding		P

IEC 62109-1			
Clause	Requirement – Test	Result – Remark	Verdict
	conductor;		
	d) through other metallic components of the PCE		N/A
	Where direct metallic contact is used and one or both of the parts involved is painted or coated, the paint or coating shall be removed in the area of contact, or reliably penetrated, to ensure metal to metal contact.	The metal enclosure is reliably penetrated earthed	P
	For moving or removable parts, hinges or sliding contacts designed and maintained to have a low resistance are examples of acceptable means if they comply with the requirements of 7.3.6.3.3.	No such design	N/A
	Metal ducts of flexible or rigid construction and metallic sheaths shall not be used as protective bonding conductors, unless the device or material has been investigated as suitable for protective bonding purposes.	No such design	N/A
7.3.6.3.3	Rating of protective bonding	The alternative of 7.3.6.3.5 is considered.	P
	Protective bonding shall withstand the highest thermal and dynamic stresses that can occur to the PCE item(s) concerned when they are subjected to a fault connecting live parts to accessible conductive parts. The protective bonding shall remain effective for as long as a fault to the accessible conductive parts persists or until an upstream protective device removes power from the part.		N/A
	Protective bonding shall meet following requirements:		N/A
	a) For PCE with an overcurrent protective device rating of 16 A or less, the impedance of the protective bonding means shall not exceed 0,1 Ω during or at the end of the test below.		N/A
	b) For PCE with an overcurrent protective device rating of more than 16 A, the voltage drop in the protective bonding test shall not exceed 2,5 V during or at the end of the test below.		N/A
	As alternative to a) and b) the protective bonding may designed according to the requirements for the external protective earthing conductor in 7.3.6.3.5, in which case no testing is required.	The alternative of 7.3.6.3.5 is considered.	N/A
	The impedance of protective bonding means shall be checked by passing a test current through the bond for a period of time as specified below. The test current is based on the rating of the overcurrent protection for the equipment or part of the equipment under consideration, as follows:		N/A
	a) For pluggable equipment type A, the		N/A

IEC 62109-1			
Clause	Requirement – Test	Result – Remark	Verdict
	overcurrent protective device is that provided external to the equipment (for example, in the building wiring, in the mains plug or in an equipment rack);		
	b) For pluggable equipment type B and fixed equipment, the maximum rating of the overcurrent protective device specified in the equipment installation instructions to be provided external to the equipment;		N/A
	c) For a circuit or part of the equipment for which an overcurrent protective device is provided as part of the equipment, the rating of the provided overcurrent device.		N/A
	Voltages are measured from the protective earthing terminal to all parts whose protective bonding means are being considered. The impedance of the protective earthing conductor is not included in the measurement. However, if the protective earthing conductor is supplied with the equipment, it is permitted to include the conductor in the test circuit but the measurement of the voltage drop is made only from the main protective earthing terminal to the accessible part required to be earthed.		N/A
	On equipment where the protective earth connection to a subassembly or to a separate unit is part of a cable that also supplies power to that subassembly or unit, the resistance of the protective bonding conductor in that cable is not included in the protective bond impedance measurements for the subassembly or separate unit, as shown in Figure 11. However, this option is only permitted if the cable is protected by a suitably rated protective device that takes into account the size of the conductor. Otherwise the impedance of the protective bonding conductor between the separate units is to be included, by measuring to the protective earthing terminal where the power source enters the first unit in the system, as shown in Figure 12.		N/A
7.3.6.3.3.1	Test current, duration, and acceptance criteria		N/A
	The test current, duration of the test and acceptance criteria are as follows:		N/A
	a) For PCE with an overcurrent protective device rating of 16 A or less, the test current is 200% of the overcurrent protective device rating, but not less than 32 A, applied for 120s. The impedance of the protective bonding means during and at the end of the test shall not exceed 0,1 Ω .		N/A
	b) For PCE with an overcurrent protective device rating of more than 16 A, the test current is		N/A

IEC 62109-1			
Clause	Requirement – Test	Result – Remark	Verdict
	200% of the overcurrent protective device rating and the duration of the test is as shown in Table 10 below. The voltage drop in the protective bonding means, during and at the end of the test, shall not exceed 2,5 V.		
	c) During and after the test, there shall be no melting, loosening, or other damage that would impair the effectiveness of the protective bonding means.		N/A
	The test current is derived from an a.c or d.c supply source, the output of which is not earthed.		N/A
	As an alternative to Table 10, where the time-current characteristic of the overcurrent protective device that limits the fault current in the protective bonding means is known because the device is either provided in the equipment or fully specified in the installation instructions, the test duration may be based on that specific device's time-current characteristic,. The tests are conducted for a duration corresponding to the 200% current value on the time-current characteristic.		N/A
7.3.6.3.4	Protective bonding impedance (routine test)	Manufacture declaration for this	N/A
	If the continuity of the protective bonding is achieved at any point by a single means only (for example a single conductor or single fastener), or if the PCE is assembled at the installation location, then the impedance of the protective bonding shall also be tested as a routine test. The test shall be as in 7.3.6.3.3, except for the following:		N/A
	<ul style="list-style-type: none"> ▪ the test current may be reduced to any convenient value greater than 10 A sufficient to allow measurement or calculation of the impedance of the protective bonding means: 		N/A
	<ul style="list-style-type: none"> ▪ the test duration may be reduced to no less than 2 s 		N/A
	For equipment subject to the type test in 7.3.6.3.3.1a), the impedance during the routine test shall not exceed 0,1Ω.		N/A
	For equipment subject to the type test in 7.3.6.3.3.1b) the impedance during the routine test shall not exceed 2,5 V divided by the test current required by 7.3.6.3.3.1b).		N/A
7.3.6.3.5	External protective earthing conductor		P
	A protective earthing conductor shall be connected at all times when power is supplied to PCE of protective class I. Unless local wiring regulations state otherwise, the protective earthing conductor	The protective earthing conductor is fixed permanently and the minimum cross-sectional area is 4mm ²	P

IEC 62109-1			
Clause	Requirement – Test	Result – Remark	Verdict
	cross-sectional area shall be determined from Table 11 or by calculation according to IEC 60364-5-54.	cable of phase and protective earthing. Only qualified personnel can install the protective earthing.	
	If the external protective earthing conductor is routed through a plug and socket or similar means of disconnection, it shall not be possible to disconnect it unless power is simultaneously removed from the part to be protected.	Permanently connected	N/A
	The cross-sectional area of every external protective earthing conductor which does not form part of the supply cable or cable enclosure shall, in any case, be not less than:		P
	<ul style="list-style-type: none"> ▪ 2,5 mm² if mechanical protection is provided; 		N/A
	<ul style="list-style-type: none"> ▪ 4 mm² if mechanical protection is not provided. 		P
	For cord-connected equipment, provisions shall be made so that the external protective earthing conductor in the cord shall, in the case of failure of the strain-relief mechanism, be the last conductor to be interrupted.	Not cord-connected equipment.	N/A
7.3.6.3.6	Means of connection for the external protective earthing conductor	External protective earthing conductors connect to the enclosure body.	P
7.3.6.3.6.1	General		P
	<p>The means of connection for the external protective earthing conductor shall be located near the terminals for the respective live conductors. The means of connections shall be corrosion-resistant and shall be suitable for the connection of cables according to 7.3.6.3.5.</p> <p>The means of connection for the protective earthing conductor shall not be used as a part of the mechanical assembly of the equipment or for other connections.</p> <p>A separate means of connection shall be provided for each external protective earthing conductor.</p> <p>Connection and bonding points shall be so designed that their current-carrying capacity is not impaired by mechanical, chemical, or electrochemical influences. Where enclosures and/or conductors of aluminium or aluminium alloys are used, particular attention should be given to the problems of electrolytic corrosion.</p>	Considered	P
	The means of connection for the protective earthing conductor shall be permanently marked with:		P
	<ul style="list-style-type: none"> • symbol 7 of Annex C; or 		P
	<ul style="list-style-type: none"> • the colour coding green-yellow 		P
	Marking shall not be done on easily changeable		P

IEC 62109-1			
Clause	Requirement – Test	Result – Remark	Verdict
	parts such as screws.		
7.3.6.3.7	Touch current in case of failure of the protective earthing conductor		P
	The requirements of this sub-clause shall be satisfied to maintain safety in case of damage to or disconnection of the protective earthing conductor.		P
	For pluggable equipment type A, the touch current measured in accordance with 7.5.4 shall not exceed 3,5 mA a.c. or mA d.c.		N/A
	For all other PCE, one or more of the following measure shall be applied, unless the touch current measured in accordance with 7.5.4 using the test network of IEC 60990 test figure 4 shall not exceed 3,5 mA a.c. or 10 mA d.c.	Living part and com. Port: 0.52 mA Live part and metal enclosure: 2.05mA	P
	a) Permanently connected wiring, and:	Not exceed 3.5mA a.c.	N/A
	<ul style="list-style-type: none"> a cross-section of the protective earthing conductor of at least 10 mm² Cu or 16 mm² Al; or 		N/A
	<ul style="list-style-type: none"> automatic disconnection of the supply in case of discontinuity of the protective earthing conductor; or 		N/A
	<ul style="list-style-type: none"> provision of an additional terminal for a second protective earthing conductor of the same cross-sectional area as the original protective earthing conductor and installation instruction requiring a second protective earthing conductor to be installed or 		N/A
	b) Connection with an industrial connector according to IEC 60309 and a minimum protective earthing conductor cross-section of 2,5 mm ² as part of a multi-conductor power cable. Adequate strain relief shall be provided.		N/A
	In addition, the caution symbol 15 of Annex C shall be fixed to the product and the installation manual shall provide details of the protective earthing measures required in the installation as required in 5.3.2.		N/A
	When it is intended and allowed to connect two or more PCEs in parallel using one common PE conductor, the above touch current requirements apply to the maximum number of the PCEs to be connected in parallel, unless one of the measures in a)		N/A
	or b) above is used. The maximum number of parallel PCEs is used in the testing and has to be stated in the installation manual.		N/A

IEC 62109-1			
Clause	Requirement – Test	Result – Remark	Verdict
7.3.6.4	Protective Class II – Double or Reinforced Insulation		P
	Equipment or parts of equipment designed for protective class II shall have insulation between live parts and accessible surfaces in accordance with 7.3.4.3. The following requirements also apply:	Signal communication port are evaluated with reinforced insulation form live parts inside	P
	<ul style="list-style-type: none"> Equipment designed to protective class II shall not have means of connection for the external protective earthing conductor. However this does not apply if the external protective earthing conductor is passed through the equipment to equipment series-connected beyond it. In the latter event, the external protective earthing conductor and its means for connection shall be insulated with basic insulation from the accessible surface of the equipment and from circuits that employ protective separation, extra-low voltage, protective impedance and limited discharging energy, according to 7.3.5. This basic insulation shall correspond to the rated voltage of the series-connected equipment; 		N/A
	<ul style="list-style-type: none"> metal-encased equipment of protective class II may have provision on its enclosure for the connection of an equipotential bonding conductor; 		N/A
	<ul style="list-style-type: none"> equipment of protective class II may have provision for the connection of an earthing conductor for functional reasons or for damping of overvoltages; it shall, however, be insulated as though it is a live part; 		N/A
	<ul style="list-style-type: none"> equipment employing protective class II shall be marked according to 5.1.8. 		N/A
7.3.7	Insulation Including Clearance and Creepage Distance		P
7.3.7.1	General		P
	This subclause gives minimum requirements for insulation, based on the principles of IEC 60664.	Considered	P
	Manufacturing tolerances shall be taken into account during measurement of creepage, clearance, and insulation distance in the PCE.	Considered	P
	Insulation shall be selected after consideration of the following influences:	Considered	P
	<ul style="list-style-type: none"> pollution degree 	PD3 outside, PD2 inside	P
	<ul style="list-style-type: none"> overvoltage category 	The mains circuits: OVC III The PV Array and battery circuits: OVC II	P

IEC 62109-1			
Clause	Requirement – Test	Result – Remark	Verdict
	<ul style="list-style-type: none"> supply earthing system 	TN	P
	<ul style="list-style-type: none"> insulation voltage 	PV input: max. 600Vdc and Main:230Vac	P
	<ul style="list-style-type: none"> location of insulation 	See table 7.3.7.4 and 7.3.7.5 for detail	P
	<ul style="list-style-type: none"> type of insulation 	See table 7.3.7.4 and 7.3.7.5 for detail	P
	Compliance of insulation, creepage distances, and clearance distances, shall be verified by measurement or visual inspection, and the tests of 7.5.		P
7.3.7.1.3	Supply earthing systems		P
	Three basic types of earthing system are described in IEC 60364-1. They are:	Inverter is intended to install in TN system	P
	<ul style="list-style-type: none"> TN system: has one point directly earthed, the accessible conductive parts of the installation being connected to that point by protective conductors. Three types of TN systems, TN-C, TN-S and TN-C-S, are defined according to the arrangement of the neutral and protective conductor. 		P
	<ul style="list-style-type: none"> TT system: has one point directly earthed, the accessible conductive parts of the installation being connected to earth electrodes electrically independent of the earth electrodes of the power system; 		N/A
	<ul style="list-style-type: none"> IT system: has all live parts isolated from earth or one point connected to earth through an impedance, the accessible conductive parts of the installation being earthed independently or collectively to the earthing system. 		N/A
7.3.7.1.4	Insulation voltages	See table 7.3.7.4 and 7.3.7.5 for detail	P
	Table 12 makes use of the circuit system voltage and overvoltage category to define the impulse withstands voltage and the temporary overvoltage.		P
7.3.7.2	Insulation between a circuit and its surroundings		P
7.3.7.2.1	General		P
7.3.7.2.2	Circuits connected directly to the mains	System voltage for mains is 300Vrms according to table 1	P
7.3.7.2.3	Circuits other than mains circuits		P
7.3.7.2.4	Insulation between circuits		P
7.3.7.3	Functional insulating		P
7.3.7.4	Clearance distances	(see appended table 7.3.7)	P
7.3.7.4.1	Determination	Designed for use in altitudes	P

IEC 62109-1			
Clause	Requirement – Test	Result – Remark	Verdict
		2000m and below.	
7.3.7.4.2	Electric field homogeneity	Inhomogeneous electric field is considered for PCE	N/A
7.3.7.4.3	Clearance to conductive enclosures		P
7.3.7.5	Creepage distances	(see appended table 7.3.7)	P
7.3.7.5.1	General		P
7.3.7.5.2	Voltage	If Working voltage less than system voltage, system voltage is used for creepage according to IEC60664-1	P
7.3.7.5.3	Materials	Certified PWB used. Other materials are considered IIIb. The inside part is considered Pollution degree 2	P
7.3.7.6	Coating		N/A
7.3.7.7	PWB spacings for functional insulating	V-0 and short circuit test are considered	P
7.3.7.8	Solid insulating	(see appended table 7.3.7)	P
7.3.7.8.1	General		P
7.3.7.8.2	Requirements for electrical withstand capability of solid insulation		P
7.3.7.8.2.1	Basic, supplemental, reinforced, and double insulation		P
7.3.7.8.2.2	Functional insulation		P
7.3.7.8.3	Thin sheet or tape material		P
7.3.7.8.3.1	General		P
7.3.7.8.3.2	Material thickness not less than 0,2 mm	Impulse test and voltage test are considered for insulation on IGBT as basic insulation	P
7.3.7.8.3.3	Material thickness less than 0,2 mm		N/A
7.3.7.8.3.4	Compliance		N/A
7.3.7.8.4	Printed wiring boards		P
7.3.7.8.4.1	General		P
7.3.7.8.4.2	Use of coating materials		N/A
7.3.7.8.5	Wound components	Varnish is not considered as insulation and voltage test performed as routine test.	P
7.3.7.8.6	Potting materials		N/A
7.3.7.9	Insulation requirements above 30 kHz		N/A
7.3.8	Residual Current-operated protective (RCD) or	Internal RCM is used. An external built RCD is not	P

IEC 62109-1			
Clause	Requirement – Test	Result – Remark	Verdict
	monitoring (RCM) device compatibility	necessary	
	RCD and RCM are used to provide protection against insulation faults in some domestic and industrial installations, additional to that provided by the installed equipment.		N/A
7.3.9	Capacitor discharge		P
7.3.9.1	Operator access area	Accessible signal communication port is DVA circuit.	P
	Equipment shall be so designed that there is no risk of electric shock in operator access areas from charge stored on capacitors after disconnection of the PCE.		P
7.3.9.2	Service access areas	Inside capacitor discharge to DVC A and no energy hazard level within 300s	P
	Capacitors located behind panels that are removable for servicing, installation, or disconnection shall present no risk of electric shock or energy hazard from charge stored on capacitors after disconnection of the PCE.	Warning symbol 21 of annex C is marked on PCE with 5min.	P
7.4	Protection against energy hazards		P
7.4.1	Determination of hazardous energy level	No such high energy level presented in the operator access area.	P
	A hazardous energy level is considered to exist if		P
	a) The voltage is 2 V or more, and power available after 60 s exceeds 240 VA.	Considered	P
	b) The stored energy in a capacitor is at a voltage. U of 2 V or more, and the stored energy. E, calculated from the following equation, exceeds 20J: $E = 0,5 CU^2$	Considered	P
7.4.2	Operator Access Areas	No energized parts accessible to user	P
	Equipment shall be so designed that there is no risk of energy hazard in operator access areas from accessible circuits.		P
7.4.3	Services Access Areas	The capacitor inside the equipment stored hazardous energy. A symbol 21 of Annex C is provided.	P
7.5	Electrical tests related to shock hazard	(see appended table 7.5)	P
7.5.1	Impulse voltage test (type test)		P

IEC 62109-1			
Clause	Requirement – Test	Result – Remark	Verdict
7.5.2	Voltage test (dielectric strength test)		P
7.5.2.1	Purpose of test		P
7.5.2.2	Value and type of test voltage		P
7.5.2.3	Humidity pre-conditioning		P
7.5.2.4	Performing the voltage test		P
7.5.2.5	Duration of the a.c. or d.c. voltage test		P
7.5.2.6	Verification of the a.c. or d.c. voltage test		P
7.5.3	Partial discharge test		N/A
7.5.4	Touch current measurement (type test)		P
	The touch current shall be measured if required by 7.3.6.3.7 and shall not be greater than 3.5 mA a.c. or 10 mA d.c. or special measures of protection as given in 7.3.6.3.7 are required.	(see appended table 7.3.6.3.7)	P
	For type tests on PCE for which wet locations requirements apply according to 6.1, the humidity pre-conditioning of 4.5 shall be performed immediately prior to the touch current test.		P
7.5.5	Equipment with multiple sources of supply		P
8	PROTECTION AGAINST MECHANICAL HAZARDS		P
8.1	General		P
	Operation shall not lead to a mechanical HAZARD in NORMAL CONDITION or SINGLE FAULT CONDITION. Edges, projections, corners, openings, guards, handles and the like, that are accessible to the operator shall be smooth and rounded so as not to cause injury during normal use of the equipment.	No mechanical hazards under the normal or single fault condition.	P
	Conformity is checked as specified in 8.2 to 8.6.		P
8.2	Moving parts		P
	Moving parts shall not be able to crush, cut or pierce parts of the body of an OPERATOR likely to contact them, nor severely pinch the OPERATOR's skin. Hazardous moving parts of equipment, that is moving parts which have the potential to cause injury, shall be so arranged, enclosed or guarded as to provide adequate protection against the risk of personal injury.		P
8.2.1	Protection of service persons		P
	Protection shall be provided such that unintentional contact with hazardous moving parts is unlikely during servicing operations. If a guard over a hazardous moving part may need to be removed for servicing, the marking of symbol 15 of Table D-1		P

IEC 62109-1			
Clause	Requirement – Test	Result – Remark	Verdict
	shall be applied on or near the guard.		
8.3	Stability		N/A
	Equipment and assemblies of equipment not secured to the building structure before operation shall be physically stable in NORMAL USE.	Wall mounted	N/A
8.4	Provisions for lifting and carrying		N/A
	If carrying handles or grips are fitted to, or supplied with, the equipment, they shall be capable of withstanding a force of four times the weight of the equipment.		N/A
	Equipment or parts having a mass of 18 kg or more shall be provided with a means for lifting and carrying or directions shall be given in the manufacturer's documentation.		N/A
8.5	Wall mounting		P
	Mounting brackets on equipment intended to be mounted on a wall or ceiling shall withstand a force of four times the weight of the equipment.		P
8.6	Expelled parts		N/A
	Equipment shall contain or limit the energy of parts that could cause a HAZARD if expelled in the event of a fault.		N/A
9	PROTECTION AGAINST FIRE HAZARDS		P
9.1	Resistance to fire		P
	This subclause specifies requirements intended to reduce the risk of ignition and the spread of flame, both within the equipment and to the outside, by the appropriate use of materials and components and by suitable construction.	PCE employed with metal enclosure reduce the risk of ignition and the spread of flame.	P
9.1.1	Reducing the risk of ignition and spread of flame		P
	For equipment or a portion of equipment, there are two alternative methods of providing protection against ignition and spread of flame that could affect materials, wiring, wound components and electronic components such as integrated circuits, transistors, thyristors, diodes, resistors and capacitors.	Method 1 used	P
9.1.2	Conditions for a fire enclosure		P
	A FIRE ENCLOSURE is required for equipment or parts of equipment for which Method 2 is not fully applied and complied with.		P
9.1.2.1	Parts requiring a fire enclosure		P
	Except where Method 2 is used, or as permitted in 9.1.2.2, the following are considered to have a risk of ignition and, therefore, require a FIRE		P

IEC 62109-1			
Clause	Requirement – Test	Result – Remark	Verdict
	ENCLOSURE:		
	– components in PRIMARY CIRCUITS		P
	– components in SECONDARY CIRCUITS supplied by power sources which exceed the limits for a LIMITED POWER SOURCE as specified in 9.2;		P
	– components in SECONDARY CIRCUITS supplied by a LIMITED POWER SOURCE as specified in 9.2, but not mounted on a material of FLAMMABILITY CLASS V-1;		N/A
	– components within a power supply unit or assembly having a limited power output complying with the criteria for a LIMITED POWER SOURCE as specified in 9.2, including overcurrent protective devices, limiting impedances, regulating networks and wiring, up to the point where the LIMITED POWER SOURCE output criteria are met;		N/A
	– components having unenclosed arcing parts, such as open switch and relay contacts and commutators, in a circuit at HAZARDOUS VOLTAGE or at a HAZARDOUS ENERGY LEVEL; and	Enclosed relay	N/A
	– insulated wiring, except as permitted in 9.1.2.2.	PVC wire	N/A
9.1.2.2	Parts not requiring a fire enclosure	Metal enclosure	N/A
9.1.3	Materials requirements for protection against fire hazard		P
9.1.3.1	General		P
	ENCLOSURES, components and other parts shall be so constructed, or shall make use of such materials, that the propagation of fire is limited.		P
9.1.3.2	Materials for fire enclosures		P
	If an enclosure material is not classified as specified below, a test may be performed on the final enclosure or part of the enclosure, in which case the material shall additionally be subjected to periodic SAMPLE testing.		P
9.1.3.3	Materials for components and other parts outside fire enclosures		P
	Except as otherwise noted below, materials for components and other parts (including MECHANICAL ENCLOSURES, ELECTRICAL ENCLOSURES and DECORATIVE PARTS); located outside FIRE ENCLOSURES, shall be of FLAMMABILITY CLASS HB.		P
9.1.3.4	Materials for components and other parts inside fire		P

IEC 62109-1			
Clause	Requirement – Test	Result – Remark	Verdict
	enclosures		
9.1.3.5	Materials for air filter assemblies		N/A
9.1.4	Openings in fire enclosures	No openings	N/A
9.1.4.1	General		N/A
	For equipment that is intended to be used or installed in more than one orientation as specified in the product documentation, the following requirements apply in each orientation.		N/A
	These requirements are in addition to those in the following sections:		N/A
	– 7.3.4, Protection against direct contact;		N/A
	– 7.4, Protection against energy hazards;		N/A
	– 13.5, Openings in enclosures		N/A
9.1.4.2	Side openings treated as bottom openings		N/A
9.1.4.3	Openings in the bottom of a fire enclosure		N/A
	The bottom of a FIRE ENCLOSURE or individual barriers, shall provide protection against emission of flaming or molten material under all internal parts, including partially enclosed components or assemblies, for which Method 2 of 9.1.1 has not been fully applied and complied with.		N/A
9.1.4.4	Equipment for use in a CLOSED ELECTRICAL OPERATING AREA		N/A
	The requirements of 9.1.4.3 do not apply to FIXED EQUIPMENT intended only for use in a CLOSED ELECTRICAL OPERATING AREA and to be mounted on a concrete floor or other non-combustible surface. Such equipment shall be marked as follows:		N/A
	WARNING: FIRE HAZARD SUITABLE FOR MOUNTING ON CONCRETE OR OTHER NON-COMBUSTIBLE SURFACE ONLY		N/A
9.1.4.5	Doors or covers in fire enclosures		N/A
9.1.4.6	Additional requirements for openings in transportable equipment		N/A
9.2	LIMITED POWER SOURCES		N/A
9.2.1	General		N/A
9.2.2	Limited power source tests		N/A
9.3	Short-circuit and overcurrent protection		P
9.3.1	General		P
	The PCE shall not present a hazard, under short-circuit or overcurrent conditions at any port, including phase-to-phase, phase-to-earth and	The circumstances of short-circuit and overcurrent are protected by the circuits	P

IEC 62109-1			
Clause	Requirement – Test	Result – Remark	Verdict
	phase-to-neutral, and adequate information shall be provided to allow proper selection of external wiring and external protective devices.	design. When short-circuit or overcurrent of components occurred, the PCE will shutdown and disconnect from the grid immediately.	
9.3.2	Protection against short-circuits and overcurrents shall be provided for all input circuits, and for output circuits that do not comply with the requirements for limited power sources in 9.2, except for circuits in which no overcurrent hazard is presented by short-circuits and overloads.	DC wire are designed for the short circuit rating of the array Short-circuit was occurred at Battery input, battery would alarm and open, no hazards.	P
9.3.3	Protective devices provided or specified shall have adequate breaking capacity to interrupt the maximum short circuit current specified for the port to which they are connected. If protection that is provided integral to the PCE for an input port is not rated for the short-circuit current of the circuit in which it is used, the installation instructions shall specify that an upstream protective device, rated for the prospective short-circuit current of that port, shall be used to provide backup protection.		P
10	PROTECTION AGAINST SONIC PRESSURE HAZARDS		N/A
10.1	General		N/A
	The equipment shall provide protection against the effect of sonic pressure. Conformity tests are carried out if the equipment is likely to cause such HAZARDS.	No sonic pressure hazards.	N/A
10.2	Sonic pressure and Sound level		N/A
10.2.1	Hazardous Noise Levels		N/A
11	PROTECTION AGAINST LIQUID HAZARDS		N/A
11.1	Liquid Containment, Pressure and Leakage		N/A
	The liquid containment system components shall be compatible with the liquid to be used.		N/A
	There shall be no leakage of liquid onto live parts as a result of:		N/A
	a) Normal operation, including condensation;		N/A
	b) Servicing of the equipment; or		N/A
	c) Inadvertent loosening or detachment of hoses or other cooling system parts over time.		N/A
11.2	Fluid pressure and leakage		N/A
11.2.1	Maximum pressure		N/A
11.2.2	Leakage from parts		N/A
11.2.3	Overpressure safety device		N/A

IEC 62109-1			
Clause	Requirement – Test	Result – Remark	Verdict
11.3	Oil and grease		N/A
12	CHEMICAL HAZARDS		N/A
12.1	General		N/A
13	PHYSICAL REQUIREMENTS		P
13.1	Handles and manual controls		P
	Handles, knobs, grips, levers and the like shall be reliably fixed so that they will not work loose in normal use, if this might result in a hazard. Sealing compounds and the like, other than self-hardening resins, shall not be used to prevent loosening. If handles, knobs and the like are used to indicate the position of switches or similar components, it shall not be possible to fix them in a wrong position if this might result in hazard.	DC breaker holder for manual controls.	P
13.1.1	Adjustable controls	No such setting control	N/A
13.2	Securing of parts		P
13.3	Provisions for external connections		P
13.3.1	General	Certified PV connectors are used. AC terminal provided for grid connection and secured by a cable gland. Installation manual provide information for the disconnection means	P
13.3.2	Connection to an a.c. Mains supply	An industrial AC connector used, and it is detachable with tool	P
13.3.2.1	General		P
	For safe and reliable connection to a MAINS supply, equipment shall be provided with one of the following:	See above	P
	– terminals or leads or a non-detachable power supply cord for permanent connection to the supply; or		P
	– a non-detachable power supply cord for connection to the supply by means of a plug		N/A
	– an appliance inlet for connection of a detachable power supply cord; or		N/A
	– a mains plug that is part of direct plug-in equipment as in 13.3.8		N/A
13.3.2.2	Permanently connected equipment		P
13.3.2.3	Appliance inlets		N/A
13.3.2.4	Power supply cord		N/A
13.3.2.5	Cord anchorages and strain relief		N/A

IEC 62109-1			
Clause	Requirement – Test	Result – Remark	Verdict
	For equipment with a non-detachable power supply cord, a cord anchorage shall be supplied such that:		N/A
	– the connecting points of the cord conductors are relieved from strain; and		N/A
	– the outer covering of the cord is protected from abrasion.		N/A
13.3.2.6	Protection against mechanical damage		P
13.3.3	Wiring terminals for connection of external conductors	DC, AC and battery terminals for connection of external conductors.	P
13.3.3.1	Wiring terminals		P
13.3.3.2	Screw terminals		P
13.3.3.3	Wiring terminal sizes		P
13.3.3.4	Wiring terminal design		P
13.3.3.5	Grouping of wiring terminals		P
13.3.3.6	Stranded wire		P
13.3.4	Supply wiring space		P
13.3.5	Wire bending space for wires 10 mm ² and greater		P
13.3.6	Disconnection from supply sources	The explanations are provided in the installation manual.	P
13.3.7	Connectors, plugs and sockets	The misconnection is unlikely for PVDC connectors and AC output connector.	P
13.3.8	Direct plug-in equipment	Permanently equipment.	N/A
13.4	Internal wiring and connections		P
13.4.1	General	All wires were used suitably and are fixed well to prevent mechanical damage during installation.	P
13.4.2	Routing	Internal wire is routed to avoid sharp edge and overheat	P
13.4.3	Colour coding	Green-yellow wire used as protective bonding only	P
13.4.4	Splices and connections		P
13.4.5	Interconnections between parts of the PCE		P
13.5	Openings in enclosures		N/A
13.5.1	Top and side openings		N/A
	Openings in the top and sides of ENCLOSURES shall be so located or constructed that it is unlikely that objects will enter the openings and create hazards by contacting bare conductive parts.		N/A

IEC 62109-1			
Clause	Requirement – Test	Result – Remark	Verdict

13.6	Polymeric Materials		P
13.6.1	General		P
13.6.1.1	Thermal index or capability		P
13.6.2	Polymers serving as enclosures or barriers preventing access to hazards		P
13.6.2.1	Stress relief test		P
13.6.3	Polymers serving as solid insulation		P
13.6.3.1	Resistance to arcing		N/A
13.6.4	UV resistance		P
	Polymeric parts of an OUTDOOR ENCLOSURE required for compliance with this standard shall be sufficiently resistance to degradation by ultra-violet (UV) radiation	The enclosure of the unit is made of metal with painting and the plastic window frame rated UV resistance according to UL 746C	P
13.7	Mechanical resistance to deflection, impact, or drop		P
13.7.1	General		P
13.7.2	250-N deflection test for metal enclosures		P
13.7.3	7-J impact test for polymeric enclosures		P
13.7.4	Drop test		N/A
13.8	Thickness requirements for metal enclosures		N/A
13.8.1	General	The metal enclosure complied with 13.7.	P
13.8.2	Cast metal		N/A
13.8.3	Sheet metal		N/A

14	COMPONENTS		P
14.1	General	(see appended table 14)	P
	Where safety is involved, components shall be used in accordance with their specified RATINGS unless a specific exception is made. They shall conform to one of the following:		P
	a) applicable safety requirements of a relevant IEC standard. Conformity with other requirements of the component standard is not required. If necessary for the application, components shall be subjected to the test of this standard, except that it is not necessary to carry out identical or equivalent tests already performed to check conformity with the component standard;		P
	b) the requirements of this standard and, where necessary for the application, any additional		P

IEC 62109-1			
Clause	Requirement – Test	Result – Remark	Verdict
	applicable safety requirements of the relevant IEC component standard;		
	c) if there is no relevant IEC standard, the requirements of this standard;		P
	d) applicable safety requirements of a non-IEC standard which are at least as high as those of the applicable IEC standard, provided that the component has been approved to the non-IEC standard by a recognized testing authority.		P
	Components such as optocouplers, capacitors, transformers, and relays connected across basic, supplemental, reinforced, or double insulation shall comply with the requirements applicable for the grade of insulation being bridged, and if not previously certified to the applicable component safety standard shall be subjected to the voltage test of 7.5.2 as routine test.		P
14.2	Motor Over temperature Protection		P
	Motors which, when stopped or prevented from starting (see 4.4.4.3), would present an electric shock HAZARD, a temperature HAZARD, or a fire HAZARD, shall be protected by an over temperature or thermal protection device meeting the requirements of 14.3.	Inverter alarm	P
14.3	Over temperature protection devices		N/A
14.4	Fuse holders		N/A
14.5	MAINS voltage selecting devices		N/A
14.6	Printed circuit boards		P
	Printed circuit boards shall be made of material with a flammability classification of V-1 of IEC 60707 or better.	V-0	P
	This requirement does not apply to thin-film flexible printed circuit boards that contain only circuits powered from limited power sources meeting the requirements of 9.2.		P
	Conformity of the flammability RATING is checked by inspection of data on the materials. Alternatively, conformity is checked by performing the V-1 tests specified in IEC 60707 on three samples of the relevant parts.		P
14.7	Circuits or components used as transient overvoltage limiting devices		N/A
	If control of transient overvoltage is employed in the equipment, any overvoltage limiting component or circuit shall be tested with the applicable impulse withstand voltage of Table 7-10 using the test method from 7.5.1 except 10 positive and 10 negative impulses are to be applied and may be		N/A

IEC 62109-1			
Clause	Requirement – Test	Result – Remark	Verdict
	spaced up to 1 min apart.		
14.8	Batteries		N/A
	Equipment containing batteries shall be designed to reduce the risk of fire, explosion and chemical leaks under normal conditions and after a single fault in the equipment including a fault in circuitry within the equipment battery pack.	Sealed lead acid battery and lithium battery of external battery pack (EBP) used. The detail installation and maintenance explanations are provided in the manufacturer's EBP of manual.	N/A
14.8.1	Battery Enclosure Ventilation	The detail installation and maintenance explanations are provided in the manufacturer's EBP of manual	N/A
14.8.1.1	Ventilation requirements		N/A
14.8.1.2	Ventilation testing		N/A
14.8.1.3	Ventilation instructions		N/A
14.8.2	Battery Mounting		N/A
	Compliance is verified by the application of the force to the battery's mounting surface. The test force is to be increased gradually so as to reach the required value in 5 to 10 s, and is to be maintained at that value for 1 min. A non-metallic rack or tray shall be tested at the highest normal condition operating temperature.		N/A
14.8.3	Electrolyte spillage		N/A
	Battery trays and cabinets shall have an electrolyte-resistant coating.		N/A
	The ENCLOSURE or compartment housing a VENTED BATTERY shall be constructed so that spillage or leakage of the electrolyte from one battery will be contained within the ENCLOSURE and be prevented from:		N/A
	a) reaching the PCE outer surfaces that can be contacted by the USER		N/A
	b) contaminating adjacent electrical components or materials; and		N/A
	c) bridging required electrical distances		N/A
14.8.4	Battery Connections		N/A
	Reverse battery connection of the terminals shall be prevented if reverse connection could result in a hazard within the meaning of this Standard		N/A
14.8.5	Battery maintenance instructions		N/A
	The information and instructions listed in 5.3.4.1 shall be included in the operator manual for equipment in which battery maintenance is		N/A

IEC 62109-1			
Clause	Requirement – Test	Result – Remark	Verdict
	performed by the operator, or in the service manual if battery maintenance is to be performed by service personnel only.		
14.8.6	Battery accessibility and maintainability		N/A
	Battery terminals and connectors shall be accessible for maintenance with the correct TOOLS. Batteries with liquid electrolyte, requiring maintained shall be so located that the battery cell caps are accessible for electrolyte tests and readjusting of electrolyte levels.		N/A
15	Software and firmware performing safety functions	Refer to annex B for details	P

IEC 62109-1			
Clause	Requirement – Test	Result – Remark	Verdict

4.2.2.6/4.7	TABLE: mains supply electrical data in normal condition/ Electrical ratings test						P
Type	U (V)DC	I (A) DC	P (W) DC	U (V)AC	I (A) AC	P (W) AC	
PV Input mode							
HYD 6000-EP	89.44	7.24	645.61	207.11	2.91	597.23	
HYD 6000-EP	89.54	7.19	641.11	230.10	2.61	591.24	
HYD 6000-EP	89.54	7.19	641.53	252.99	2.39	589.07	
HYD 6000-EP	299.79	21.04	6308.15	207.68	28.96	6011.19	
HYD 6000-EP	299.56	21.06	6308.65	230.62	26.16	6029.82	
HYD 6000-EP	299.36	21.07	6308.38	253.07	23.88	6042.06	
HYD 6000-EP	520.36	12.07	6272.96	207.69	29.00	6018.75	
HYD 6000-EP	520.86	12.06	6272.32	230.63	26.26	6051.19	
HYD 6000-EP	520.79	12.06	6272.04	253.08	24.03	6077.14	
HYD 3000-EP	91.13	7.58	689.07	207.12	3.11	639.26	
HYD 3000-EP	91.15	7.58	689.25	230.11	2.81	637.50	
HYD 3000-EP	91.17	7.56	688.09	253.11	2.56	634.37	
HYD 3000-EP	160.75	19.42	3120.18	207.28	14.58	3019.68	
HYD 3000-EP	160.75	19.42	3119.10	230.26	13.13	3019.23	
HYD 3000-EP	160.92	19.36	3112.36	253.04	11.92	3011.58	
HYD 3000-EP	520.32	6.04	3136.72	207.37	14.64	3034.96	
HYD 3000-EP	520.78	6.02	3131.97	230.34	13.21	3041.15	
HYD 3000-EP	520.82	6.01	3128.98	252.82	12.06	3046.66	
Type	U (V)DC	I (A) DC	P (W) DC	U (V)AC	I (A) AC	P (W)AC	
Stand-alone mode							
HYD 6000-EP	94.97	7.71	675.16	225.77	2.75	621.15	
HYD 6000-EP	298.86	18.01	5383.16	225.53	22.70	5119.00	
HYD 6000-EP	518.83	10.27	5325.00	225.37	21.78	4909.07	
Type	U (V)AC	I (A) AC	P (W) AC	U (V)DC	I (A) DC	P (W) DC	
AC charging mode							
HYD 6000-EP	207.20	25.23	5216.52	54.53	88.32	4815.64	
HYD 6000-EP	229.83	22.67	5197.53	54.59	88.29	4819.60	
HYD 6000-EP	252.93	20.58	5191.68	54.73	88.27	4830.81	
HYD 3000-EP	207.20	15.60	3222.90	54.23	55.55	3012.40	
HYD 3000-EP	230.28	13.99	3210.55	54.41	55.37	3012.70	
HYD 3000-EP	250.33	12.89	3214.00	54.46	55.51	3022.79	
Type	U (V)DC	I (A) DC	P (W) DC	U (V)AC	I (A) AC	P (W) AC	
Battery discharging mode							
HYD 6000-EP	52.03	100.94	5251.14	207.17	23.27	4822.46	
HYD 6000-EP	51.97	101.01	5248.32	230.05	21.07	4846.61	
HYD 6000-EP	51.91	102.69	5330.29	252.97	19.47	4923.68	
HYD 3000-EP	52.42	61.37	3216.58	207.22	14.52	3007.01	
HYD 3000-EP	52.39	61.44	3218.96	229.66	13.15	3018.91	
HYD 3000-EP	52.36	61.42	3215.77	253.09	11.94	3019.78	
Type	U (V)DC	I (A) DC	P (W) DC	U (V)	I (A) AC	P (W) AC	
PV input for battery charging and AC output mode							
HYD 6000-EP	94.89	7.12	675.20	207.13Vac	0.20	40.84	
				53.71Vdc	11.05	592.54	
HYD 6000-EP	94.88	7.12	675.51	230.17Vac	0.15	35.43	
				53.94Vdc	11.30	608.73	
HYD 6000-EP	94.93	7.12	675.25	253.22Vac	0.15	38.22	
				53.92Vdc	11.35	611.53	

IEC 62109-1						
Clause	Requirement – Test			Result – Remark		Verdict

HYD 6000-EP	298.96	18.01	5383.44	207.03Vac	0.27	55.86
				55.00Vdc	89.99	2988
HYD 6000-EP	298.91	18.01	5383.57	230.13Vac	0.21	48.38
				54.98Vdc	90.11	4954.20
HYD 6000-EP	298.97	18.01	5383.62	253.18Vac	0.17	42.36
				54.97Vdc	90.22	4959.67
HYD 6000-EP	519.27	10.41	5403.74	207.14Vac	0.06	12.46
				55.05Vdc	91.86	5057.13
HYD 6000-EP	519.02	10.41	5403.28	230.18Vac	0.05	11.64
				55.07Vdc	91.84	5057.44
HYD 6000-EP	519.28	10.41	5403.84	253.23Vac	0.02	6.19
				55.09Vdc	91.90	5062.29
HYD 3000-EP	94.88	7.12	675.21	207.13Vac	0.007	14.14
				53.74Vdc	11.01	590.99
HYD 3000-EP	94.88	7.12	675.68	230.17Vac	0.14	31.25
				53.91Vdc	11.24	605.31
HYD 3000-EP	94.88	6.98	661.95	253.22Vac	0.20	49.87
				53.93Vdc	11.32	609.83
HYD 3000-EP	162.45	20.54	3336.07	207.07Vac		16.22
				54.48Vdc	55.26	3010.54
HYD 3000-EP	162.51	20.50	3331.47	230.17Vac	0.00	0.81
				54.85Vdc	55.01	3017.24
HYD 3000-EP	162.81	20.44	3327.59	253.23Vac	0.08	20.44
				54.90Vdc	55.17	3028.50
HYD 3000-EP	519.99	6.14	3192.80	207.13Vac	0.05	10.27
				54.54Vdc	55.61	3032.57
HYD 3000-EP	519.59	6.14	3192.77	230.17Vac	0.06	13.98
				54.55Vdc	55.67	3036.49
HYD 3000-EP	520.25	6.14	3192.71	253.23Vac	0.04	10.05
				54.58Vdc	55.57	3032.67

IEC 62109-1			
Clause	Requirement – Test	Result – Remark	Verdict

4.3 TABLE: Thermal testing (PV input for all AC output mode)					P
Model :	HYD 6000-EP				-
temperature t of part/at:	t (°C)				permitted t (°C)
test Condition :	300Vdc,21.0A; 207Vac,29.0A	300Vdc,18.6A; 207Vac,25.7A	300Vdc,21.0A; 253Vac, 23.7A	300Vdc, 17.2A; 253Vac,19.4A	-
Ambient	45.0	60.6	45.5	60.54	-
Enclosure, front	58.0	68.1	56.0	68.3	100*
Display panel	51.9	64.5	51.0	64.4	75
Load terminal	49.9	63.0	49.3	63.3	90
DC switch	49.1	62.8	47.5	61.6	85
PV terminal	53.4	65.1	52.2	64.8	90
PCB on display board	65.9	74.3	63.9	74.5	130
Enclosure, side	56.8	68.3	56.2	68.3	100*
Mounting surface	69.8	75.6	71.0	74.5	90
Enclosure, top	63.3	72.3	62.8	73.9	100*
Relay RY1	74.8	81.9	71.0	79.9	85
PCB on the output board	82.5	87.8	75.7	83.5	130
X Cap, C94	69.3	76.7	65.7	76.1	110
Film cap C145	70.0	77.6	68.4	77.6	105
MOV RVP5	69.4	77.0	67.6	77.1	85
Y Cap C138	68.9	76.1	66.6	76.5	125
Capacitor C146	69.1	76.7	66.5	76.6	105
Relay RL9	68.8	75.9	65.0	75.8	85
Hall HL4	68.9	76.3	65.8	76.3	85
DC chock L1	80.7	80.6	79.4	83.9	110
PV power line	75.1	71.9	61.4	72.3	105
DC switch, inside	65.0	72.6	62.5	73.6	85
DC chock L2	84.6	84.2	78.7	85.4	110
DC chock lead wires	68.3	75.1	65.4	76.0	105
INV chock lead wires	71.9	77.9	67.5	77.6	105
INV chock L4	91.3	95.7	85.7	92.6	110
DC chock P8	68.5	74.0	66.1	75.8	110
MCU U1	80.7	79.8	68.5	79.1	Reference

IEC 62109-1					
Clause	Requirement – Test			Result – Remark	Verdict

DC Filter L15	71.6	77.5	69.6	78.1	110
Optocoupler U14	90.5	95.8	82.7	90.9	115
Optocoupler U17	76.7	79.6	74.8	83.3	115
Capacitor C172	70.7	77.9	67.1	77.5	100
C13	69.0	76.2	65.6	76.4	105
Relay RL3	66.4	74.6	63.6	74.7	85
Transformer TX1	68.1	76.6	65.7	77.0	110
MCU U4	69.6	78.0	66.8	78.1	Reference
Bus capacitor C8	65.7	73.6	62.6	73.8	105
Inner ambient temperature	66.8	75.3	64.2	75.5	Reference
Bus Cap C10	75.5	76.4	72.8	81.8	105
PCB on power board	65.0	72.8	62.4	73.5	130
Fan	70.4	72.8	68.2	73.8	80
Relay RL1	67.0	75.5	64.7	75.0	85
Hall HL1	67.8	75.1	65.3	76.0	85
X Cap C103	70.3	76.9	66.5	76.9	110
C107	69.1	76.2	65.9	76.4	105
GFCI L10	88.4	93.7	78.6	85.8	110
AC Filter L8	73.8	80.3	69.6	78.7	110
Optocoupler U26	76.7	83.5	71.7	81.1	100
AC Filter L9	82.2	86.6	73.7	82.7	110
Y Cap C114	70.6	78.0	66.5	76.7	125
AC output wires	71.2	79.1	66.9	77.0	105
AC terminal	66.7	74.1	61.6	72.9	90
Battery power line	64.6	71.9	61.9	73.1	105
Battery terminal	62.2	70.6	61.4	71.2	90
IGBT Q5 for PCB	83.1	92.8	78.3	88.0	130
IGBT Q4 for PCB	86.0	97.2	75.9	81.0	130
IGBT Q3 for PCB	88.0	96.8	82.0	91.9	130

IEC 62109-1			
Clause	Requirement – Test	Result – Remark	Verdict

4.3 TABLE: Thermal testing (PV input for all AC output mode)					P
Model :	HYD 6000-EP				—
temperature t of part/at:	t (°C)				permitted t (°C)
test Condition :	520Vdc,12.1A; 207Vac,29.0A	520Vdc,9.4A; 207Vac,22.5A	520Vdc,12.1A; 253Vac, 23.7A	520Vdc, 10.7A; 253Vac,21.0A	—
Ambient	45.5	60.6	44.9	60.7	—
Enclosure, front	56.4	68.4	53.9	68.0	100*
Display panel	51.6	64.6	52.4	64.4	75
Load terminal	50.2	63.9	52.7	63.4	90
DC switch	49.9	61.5	52.8	61.4	85
PV terminal	51.4	64.4	52.8	64.1	90
PCB on display board	63.8	74.5	60.0	73.5	130
Enclosure, side	56.2	68.2	54.6	67.6	100*
Mounting surface	72.5	61.0	71.9	75.3	90
Enclosure, top	62.3	73.5	59.0	72.5	100*
Relay RY1	74.2	82.9	67.4	80.1	85
PCB on the output board	81.0	89.7	72.0	84.7	130
X Cap, C94	66.4	76.5	62.0	75.3	110
Film cap C145	67.6	77.5	63.3	76.5	105
MOV RVP5	67.3	77.2	63.0	76.2	85
Y Cap C138	65.5	76.0	61.5	74.9	125
Capacitor C146	65.9	76.3	61.7	75.2	105
Relay RL9	65.9	76.2	61.7	74.9	85
Hall HL4	66.0	76.2	61.5	75.1	85
DC chock L1	69.9	79.3	64.8	78.4	110
PV power line	60.8	71.5	57.4	71.3	105
DC switch, inside	62.1	72.6	58.2	72.2	85
DC chock L2	78.1	86.0	69.9	83.8	110
DC chock lead wires	64.8	75.3	60.7	74.7	105
INV chock lead wires	68.3	77.7	62.8	76.7	105
INV chock L4	94.9	101.7	81.0	95.1	110
DC chock P8	62.7	73.6	59.7	73.0	110
MCU U1	69.5	79.5	65.1	78.6	Reference

IEC 62109-1					
Clause	Requirement – Test			Result – Remark	Verdict

DC Filter L15	66.8	76.8	62.7	76.2	110
Optocoupler U14	87.2	97.5	78.9	93.2	115
Optocoupler U17	68.8	78.9	64.4	78.2	115
Capacitor C172	68.2	78.0	63.4	77.0	100
C13	66.1	76.3	61.7	75.7	105
Relay RL3	64.0	74.5	60.0	74.0	85
Transformer TX1	66.8	77.3	62.9	76.7	110
MCU U4	67.3	77.9	63.4	77.4	Reference
Bus capacitor C8	63.0	73.5	59.2	73.1	105
Inner ambient temperature	65.0	75.8	61.4	75.1	Reference
Bus Cap C10	65.3	75.5	61.2	75.1	105
PCB on power board	61.9	72.7	58.3	72.2	130
Fan	68.1	78.5	64.5	73.8	80
Relay RL1	65.8	75.6	61.3	74.8	85
Hall HL1	65.0	75.3	60.7	74.5	85
X Cap C103	67.4	77.1	62.5	76.1	110
C107	67.0	76.8	62.1	75.6	105
GFCI L10	89.2	98.8	77.0	90.2	110
AC Filter L8	72.5	80.9	66.0	78.9	110
Optocoupler U26	75.1	84.2	68.4	81.6	100
AC Filter L9	78.7	87.7	70.3	84.2	110
Y Cap C114	69.1	78.1	63.6	76.8	125
AC output wires	70.5	80.0	64.4	77.8	105
AC terminal	64.0	74.5	59.5	73.1	90
Battery power line	61.8	72.6	58.2	72.1	105
Battery terminal	59.6	70.7	56.4	70.4	90
IGBT Q5 for PCB	81.8	93.7	74.7	89.1	130
IGBT Q4 for PCB	87.9	101.1	79.1	89.1	130
IGBT Q3 for PCB	94.5	106.4	81.7	95.7	130

IEC 62109-1			
Clause	Requirement – Test	Result – Remark	Verdict

4.3 TABLE: Thermal testing (Battery charging and discharging)					P
Model :	HYD 6000-EP				-
temperature t of part/at:	t (°C)				permitted t (°C)
test Condition :	52Vdc,100.9A; 207Vac,23.3A	52Vdc,79.8A; 207Vac19.1A	52Vdc,102.7A; 253Vac, 19.5A	52Vdc, 80.1A; 253Vac,15.4A	-
Ambient	45.3	60.2	44.8	60.2	-
Enclosure, front	61.7	72.1	60.9	70.3	100*
Display panel	55.2	70.3	54.7	66.2	75
Load terminal	51.3	70.2	50.6	63.8	90
DC switch	50.8	70.2	50.4	62.9	85
PV terminal	55.1	70.7	54.7	65.8	90
PCB on display board	73.6	78.5	72.2	78.0	130
Enclosure, side	59.8	72.6	59.3	69.1	100*
Mounting surface	73.4	78.7	69.9	77.9	90
Enclosure, top	69.2	75.6	67.4	75.1	100*
Relay RY1	79.7	81.9	75.6	80.8	85
PCB on the output board	84.3	83.7	77.6	81.9	130
X Cap, C94	75.0	79.2	72.8	78.7	110
Film cap C145	75.3	80.0	74.1	80.8	105
MOV RVP5	74.8	79.3	72.9	78.8	85
Y Cap C138	75.7	80.0	74.2	79.5	125
Capacitor C146	76.4	80.5	74.9	80.0	105
Relay RL9	76.0	79.8	74.0	79.4	85
Hall HL4	77.9	80.9	75.9	80.4	85
DC chock L1	81.6	84.4	81.9	85.2	110
PV power line	73.1	77.5	72.6	77.6	105
DC switch, inside	73.4	77.6	72.2	77.6	85
DC chock L2	89.3	89.8	90.6	91.7	110
DC chock lead wires	82.0	85.1	81.3	85.1	105
INV chock lead wires	79.1	80.9	76.3	80.6	105
INV chock L4	90.4	86.8	81.4	85.3	110
DC chock P8	99.3	96.1	100.2	96.8	110
MCU U1	77.2	81.8	75.0	81.4	Reference

IEC 62109-1					
Clause	Requirement – Test			Result – Remark	Verdict

DC Filter L15	75.5	79.7	73.7	79.5	110
Optocoupler U14	93.1	91.4	84.5	88.9	115
Optocoupler U17	85.5	90.4	86.0	91.0	115
Capacitor C172	83.0	84.4	80.7	83.8	100
C13	82.5	84.1	81.6	84.1	105
Relay RL3	77.3	80.5	75.8	80.4	85
Transformer TX1	76.2	80.8	74.6	80.9	110
MCU U4	77.9	82.3	76.3	82.3	Reference
Bus capacitor C8	81.3	83.9	80.8	84.0	105
Inner ambient temperature	75.0	79.7	73.7	78.8	Reference
Bus Cap C10	76.8	80.6	76.3	80.8	105
PCB on power board	97.5	106.6	98.8	107.4	130
Fan	77.3	75.6	75.4	73.8	80
Relay RL1	74.9	79.1	73.3	78.8	85
Hall HL1	76.8	80.2	75.4	80.0	85
X Cap C103	79.2	81.4	77.1	81.1	110
C107	77.9	80.7	76.0	80.4	105
GFCI L10	89.5	85.0	79.4	83.1	110
AC Filter L8	78.1	80.1	73.9	79.4	110
Optocoupler U26	81.3	82.8	77.1	82.2	100
AC Filter L9	86.7	84.4	80.1	83.1	110
Y Cap C114	75.4	78.6	72.0	78.1	125
AC output wires	76.0	78.3	71.5	77.5	105
AC terminal	69.0	74.4	65.9	73.8	90
Battery power line	75.9	80.2	75.5	80.6	105
Battery terminal	68.8	75.3	68.6	75.1	90
IGBT Q5 for PCB	79.1	82.7	75.1	81.7	130
IGBT Q4 for PCB	87.8	89.4	82.2	90.3	130
IGBT Q3 for PCB	101.5	94.1	85.7	89.9	130

IEC 62109-1			
Clause	Requirement – Test	Result – Remark	Verdict

4.3 TABLE: Thermal testing (Stand-alone mode)			P
Model :	HYD 6000-EP		-
temperature t of part/at:	t (°C)		permitted t (°C)
test Condition :	AC output:230V,5kW	AC output power derating to 0W and then restore, cycle	-
Ambient	45.1	60.0	-
Enclosure, front	63.4	72.1	100*
Display panel	55.5	67.5	75
Load terminal	56.9	67.8	90
DC switch	50.0	63.7	85
PV terminal	54.4	66.8	90
PCB on display board	74.1	79.1	130
Enclosure, side	60.0	69.4	100*
Mounting surface	67.8	77.9	90
Enclosure, top	69.4	76.8	100*
Relay RY1	79.1	79.2	85
PCB on the output board	78.5	78.0	130
X Cap, C94	78.0	79.1	110
Film cap C145	78.5	79.8	105
MOV RVP5	77.6	78.6	85
Y Cap C138	79.1	79.5	125
Capacitor C146	80.3	79.8	105
Relay RL9	78.9	81.5	85
Hall HL4	82.0	83.6	85
DC chock L1	87.7	81.7	110
PV power line	77.9	80.5	105
DC switch, inside	77.3	78.8	85
DC chock L2	97.9	90.0	110
DC chock lead wires	88.2	89.4	105
INV chock lead wires	82.0	84.0	105
INV chock L4	89.7	84.9	110
DC chock P8	111.7	97.0	110
MCU U1	81.1	82.9	Reference

IEC 62109-1			
Clause	Requirement – Test	Result – Remark	Verdict

DC Filter L15	79.1	79.0	110
Optocoupler U14	93.2	95.7	115
Optocoupler U17	91.2	93.9	115
Capacitor C172	87.6	88.2	100
C13	89.3	86.9	105
Relay RL3	81.5	84.5	85
Transformer TX1	79.1	81.0	110
MCU U4	81.2	84.1	Reference
Bus capacitor C8	88.4	88.2	105
Inner ambient temperature	78.2	78.8	Reference
Bus Cap C10	81.0	83.0	105
PCB on power board	111.8	112.8	130
Fan	75.1	84.8	80
Relay RL1	78.2	81.5	85
Hall HL1	80.6	82.2	85
X Cap C103	83.0	82.9	110
C107	81.4	80.7	105
GFCI L10	89.7	88.0	110
AC Filter L8	76.6	76.3	110
Optocoupler U26	86.1	85.6	100
AC Filter L9	89.1	86.8	110
Y Cap C114	75.7	76.3	125
AC output wires	74.1	76.4	105
AC terminal	69.2	73.8	90
Battery power line	81.6	84.7	105
Battery terminal	72.8	77.9	90
IGBT Q5 for PCB	80.0	85.1	130
IGBT Q4 for PCB	95.6	83.1	130
IGBT Q3 for PCB	86.9	94.3	130

IEC 62109-1			
Clause	Requirement – Test	Result – Remark	Verdict

Supplementary information: *the parts are marked with the hot surface marking of symbol 14 of Annex C.					
TABLE: Heating test, resistance method					N/A
Temperature rise of winding	R ₁ (Ω)	R ₂ (Ω)	ΔT (K)	Max. dT (K)	Insulation class
Supplementary information:					

IEC 62109-1			
Clause	Requirement – Test	Result – Remark	Verdict

.4		TABLE: fault condition tests					P
		ambient temperature (°C): 24.6					—
No.	component No.	fault	test voltage (V)	test time	fuse No.	fuse current (A)	result
1	Relay RL4	Short circuit before energized	Input:520V dc Output:230 Vac	10min	--	--	Indicate Relay fault, error code "ID41" (RecoverRelayFail). Do not connect to AC mainsn. No damage, no hazards.
2	Relay RL1	Short circuit before energized	Input:520V dc Output:230 Vac	10min	--	--	Indicate Relay fault, error code "ID41" (RecoverRelayFail). Do not connect to AC mainsn. No damage, no hazards.
3	Relay RL2	Short circuit before energized	Input:520V dc Output:230 Vac	10min	--	--	Indicate Relay fault, error code "ID41" (RecoverRelayFail). Do not connect to AC mainsn. No damage, no hazards.
4	Relay RL5	Short circuit before energized	Input:520V dc Output:230 Vac	10min	--	--	Indicate Relay fault, error code "ID41" (RecoverRelayFail). Do not connect to AC mainsn. No damage, no hazards.
5	Rectifier bridge BR1	S/C	Input:520V dc Output:230 Vac	10min	--	--	Output a.c. relays operated immediately, disconnected with grid. No damage, no hazards.
6	Q23 (Pin G-S)	Short circuit before energized	Input:520V dc Output:230 Vac	10min	--	--	Indicate Relay fault, error code "ID41" (RecoverRelayFail). Do not connect to AC mainsn. No damage, no hazards.
7	Q17 (Pin G-S)	Short circuit before energized	Input:520V dc Output:230 Vac	10min	--	--	Indicate Relay fault, error code "ID41" (RecoverRelayFail). Do not connect to AC mainsn. No damage, no hazards.
8	Q18 (Pin G-S)	Short circuit before energized	Input:520V dc Output:230 Vac	10min	--	--	Indicate Relay fault, error code "ID41" (RecoverRelayFail). Do not connect to AC mainsn. No damage, no hazards.

IEC 62109-1							
Clause	Requirement – Test				Result – Remark		Verdict
9	Q16 (Pin G-S)	Short circuit before energized	Input:520V dc Output:230 Vac	10min	--	--	Indicate Relay fault, error code "ID41" (RecoverRelayFail). Do not connect to AC mainsn. No damage, no hazards
10	RCM/LP1 pin GND-Vout	S/C	Input:520V dc Output:230 Vac	10min	--	--	Output a.c. relays operated, disconnected with grid , error code "ID05" (GFCI fault). No hazards.
11	Monitoring voltage defect R203	O/C	Input:520V dc Output:230 Vac	10min	--	--	Output a.c. relays operated, disconnected with grid, error code "GridUVP". No damage. No hazards.
12	Monitoring voltage defect R219	O/C	Input:520V dc Output:230 Vac	10min	--	--	Output a.c. relays operated, disconnected with grid, error code "GridUVP". No damage. No hazards.
13	U1 pin 485-1TX 485-1RX	S/C	Input:520V dc Output:230 Vac	10min	--	--	Output a.c. relays operated, disconnected with grid. 4851 Communication failure . No damage. No hazards.
14	U1 pin 485-2TX 485-2RX	S/C	Input:520V dc Output:230 Vac	10min	--	--	Output a.c. relays operated, disconnected with grid. 4852 Communication failure . No damage. No hazards.
15	U1 pin ARMToDSP ARMFrom DSP-TX	S/C	Input:520V dc Output:230 Vac	10min	--	--	Output a.c. relays operated, disconnected with grid. SCI Communication failure . No damage. No hazards.
16	U1 pin M_CAN_RX M_CAN_TX	S/C	Input:520V dc Output:230 Vac	10min	--	--	Output a.c. relays operated, disconnected with grid. CAN Communication failure . No damage. No hazards
17	U1, +3.3V.S	O/C	Input:520V dc Output:230 Vac	10min	--	--	Output a.c. relays operated, disconnected with grid. SCI Communication failure . No damage. No hazards
18	PV voltage monitoring R283	S/C	Input:520V dc Output:230 Vac	10min	--	--	Output a.c. relays operated, disconnected with grid. No damage. No hazards

IEC 62109-1							
Clause	Requirement – Test				Result – Remark		Verdict
19	PV voltage monitoring R277	S/C	Input:520V dc Output:230 Vac	10min	--	--	Output a.c. relays operated, disconnected with grid. No damage. No hazards
20	L to N(grid)	Reversed	Input:520V dc Output:230 Vac	10min	--	--	EUT operationed normally. No damage, no hazards.
21	C324	S/C	Input:520V dc Output:230 Vac	10min	--	--	Output a.c. relays operated, disconnected with grid. L2, L7 damaged. No hazards.
22	EC2	S/C	Input:520V dc Output:230 Vac	10min	--	--	Output a.c. relays operated, disconnected with grid. EC2 damaged. No hazards.
23	EC3	S/C	Input:520V dc Output:230 Vac	10min	--	--	Output a.c. relays operated, disconnected with grid. EC3 damaged. No hazards
24	Q61 pin D-S	S/C	Input:520V dc Output:230 Vac	10min	--	--	Output a.c. relays operated, disconnected with grid. No damaged. No hazards
25	Q16 pin D-S	S/C	Input:520V dc Output:230 Vac	10min	--	--	Output a.c. relays operated, disconnected with grid, error code "ID81" (SwBatOCP). No damage, no hazards.
26	Q17 pin D-S	S/C	Input:520V dc Output:230 Vac	10min	--	--	Output a.c. relays operated, disconnected with grid, error code "ID81" (SwBatOCP). No damage, no hazards..
27	Q18 pin D-S	S/C	Input:520V dc Output:230 Vac	10min	--	--	Output a.c. relays operated, disconnected with grid, error code "ID81" (SwBatOCP). No damage, no hazards..
28	Q19 pin D-S	S/C	Input:520V dc Output:230 Vac	10min	--	--	Output a.c. relays operated, disconnected with grid, error code "ID81" (SwBatOCP). No damage, no hazards..

IEC 62109-1							
Clause	Requirement – Test					Result – Remark	Verdict
29	D13	S/C	Input:520V dc Output:230 Vac	10min	--	--	Output a.c. relays operated, disconnected with grid, error code "ID69" (PVOVP). No damaged, no hazards..
30	R28	O/C	Input:520V dc Output:230 Vac	10min	--	--	Output a.c. relays operated, disconnected with grid, error code "ID69" (PVOVP). No damaged, no hazards.
31	R68	O/C	Input:520V dc Output:230 Vac	10min	--	--	Output a.c. relays operated, disconnected with grid, error code "ID71" (LLCBusOVP). No damaged, no hazards.
32	R32	O/C	Input:520V dc Output:230 Vac	10min	--	--	Output a.c. relays operated, disconnected with grid, error code "ID71" (LLCBusOVP). No damaged, no hazards.
33	R71	O/C	Input:520V dc Output:230 Vac	10min	--	--	Output a.c. relays operated, disconnected with grid, error code "ID71" (LLCBusOVP). No damaged, no hazards.
34	Q27	S/C	Input:520V dc Output:230 Vac	10min	--	--	Output a.c. relays operated, disconnected with grid, error code "ID71" (LLCBusOVP). No damaged, no hazards.
35	Q9 pin G-C	S/C	Input:520V dc Output:230 Vac	10min	--	--	The EUT shut down immediately. Q9,Q13 damaged, no hazards.
36	Q8 pin G-C	S/C	Input:520V dc Output:230 Vac	10min	--	--	The EUT shut down immediately. Q8,Q14 damaged, no hazards.
37	Q7 pin G-C	S/C	Input:520V dc Output:230 Vac	10min	--	--	The EUT shut down immediately. Q7 damaged, no hazards.
38	Q12 pin G-C	S/C	Input:520V dc Output:230 Vac	10min	--	--	The EUT shut down immediately. Q12 damaged, no hazards.

IEC 62109-1							
Clause	Requirement – Test				Result – Remark		Verdict
39	Q1 pin G-S	S/C	Input:520V dc Output:230 Vac	10min	--	--	The EUT shut down immediately. Q1,Q2,Q3,Q6 damaged, no hazards.
40	Q2 pin G-S	S/C	Input:520V dc Output:230 Vac	10min	--	--	The EUT shut down immediately. Q1,Q2,Q3,Q6 damaged, no hazards.
41	R531	Shorted before start up	Input:520V dc Output:230 Vac	10min	--	--	Indicate ISO fault, error code"ID42 (IsoFault)", No damaged, No hazards
42	R602	Shorted before start up	Input:520V dc Output:230 Vac	10min	--	--	Indicate ISO fault, error code"ID42 (IsoFault)", No damaged, No hazards
43	R611	Shorted before start up	Input:520V dc Output:230 Vac	10min	--	--	Indicate ISO fault, error code"ID42 (IsoFault)", No damaged, No hazards
44	R620	Shorted before start up	Input:520V dc Output:230 Vac	10min	--	--	Indicate ISO fault, error code"ID42 (IsoFault)", No damaged, No hazards
45	EC25	Shorted before start up	Input:520V dc Output:230 Vac	10min	--	--	Indicate ISO fault, error code"ID42 (IsoFault)", No damaged, No hazards
46	EC27	S/C	Input:520V dc Output:230 Vac	10min	--	--	Output a.c.relays operated, disconnected with grid. error code"ID17(HwADFaultIGrid) No damaged. No hazards.
47	EC16	S/C	Input:520V dc Output:230 Vac	10min	--	--	Output a.c.relays operated, disconnected with grid. error code"ID17(HwADFaultIGrid) No damaged. No hazards.
48	EC17	S/C	Input:520V dc Output:230 Vac	10min	--	--	Output a.c.relays operated, disconnected with grid. error code"ID17(HwADFaultIGrid) No damaged. No hazards.

IEC 62109-1							
Clause	Requirement – Test				Result – Remark		Verdict
49	EC29	S/C	Input:520V dc Output:230 Vac	10min	--	--	Output a.c.relays operated, disconnected with grid. error code"ID17(HwADFaultIGrid) No damaged. No hazards.
50	EC31	S/C	Input:520V dc Output:230 Vac	10min	--	--	Output a.c.relays operated, disconnected with grid. error code"ID17(HwADFaultIGrid) No damaged. No hazards.
51	EC18	S/C	Input:520V dc Output:230 Vac	10min	--	--	Output a.c.relays operated, disconnected with grid. error code"ID17(HwADFaultIGrid) No damaged. No hazards.
52	EC23	S/C	Input:520V dc Output:230 Vac	10min	--	--	Output a.c.relays operated, disconnected with grid. error code"ID17(HwADFaultIGrid) No damaged. No hazards.
53	EC32	S/C	Input:520V dc Output:230 Vac	10min	--	--	Output a.c.relays operated, disconnected with grid. SCI Communication failure No damaged. No hazards.
54	U4 pin M_LINRX M_LINTX	S/C	Input:520V dc Output:230 Vac	10min	--	--	Output a.c.relays operated, disconnected with grid. M_LINRX Communication failure No damaged. No hazards.
55	INSYN, TX1, INSYN, RX1	S/C	Input:520V dc Output:230 Vac	10min	--	--	Output a.c.relays operated, disconnected with grid. error code"ID47(ParallelFault) No damaged. No hazards.
56	C384	S/C	Input:520V dc Output:230 Vac	10min	--	--	Output a.c.relays operated, disconnected with grid. error code"ID81(SwBatOCP) No damaged. No hazards.
57	EC6	S/C	Input:520V dc Output:230 Vac	10min	--	--	The EUT shut down immediately. No damaged, no hazards.

IEC 62109-1							
Clause	Requirement – Test			Result – Remark		Verdict	
58	EC9	S/C	Input:520V dc Output:230 Vac	10min	--	--	The EUT shut down immediately. No damaged, no hazards.
59	EC11	S/C	Input:520V dc Output:230 Vac	10min	--	--	The EUT shut down immediately. No damaged, no hazards.
60	U58	S/C	Input:520V dc Output:230 Vac	10min	--	--	The EUT shut down immediately. No damaged, no hazards.
61	C463	S/C	Input:520V dc Output:230 Vac	10min	--	--	Output a.c.relays operated, disconnected with grid. error code"GFCI fault" No damaged. No hazards.
62	C105	S/C	Input:520V dc Output:230 Vac	10min	--	--	Output a.c.relays operated, disconnected with grid. error code"CT current fault" No damaged. No hazards.
63	C130	S/C	Input:520V dc Output:230 Vac	10min	--	--	Output a.c.relays operated, disconnected with grid. error code" OverTempDerating" No damaged. No hazards.
64	C107	S/C	Input:520V dc Output:230 Vac	10min	--	--	Output a.c.relays operated, disconnected with grid. error code" HwLLCBusOCP" No damaged. No hazards.
65	C120	S/C	Input:520V dc Output:230 Vac	10min	--	--	Output a.c.relays operated, disconnected with grid. error code" HwLLCBusOCP" No damaged. No hazards.
66	PV1+ and PV1-	Revers ed	Input:520V dc Output:230 Vac	10min	--	--	PCE did not work, indicate: PV1 HWOCP;PV1 OCP No damaged. No hazards.
67	Bat+ and Bat-	Revers ed	Input:520V dc Output:230 Vac	10min	--	--	PCE did not work, Q16,Q17,Q18,Q19,Q21,Q2 2,Q23,Q24 damaged. No hazards.
68	Bat+ and Bat-	S/C	Input:520V dc Output:230 Vac	10min	--	--	PCE did not work, Q16,Q17,Q18,Q19,Q21,Q2 2,Q23,Q24 damaged. No hazards.

IEC 62109-1			
Clause	Requirement – Test	Result – Remark	Verdict

<p>supplementary information S/C: Short circuit, O/C: Open circuit During the test: Fire do not propagates beyond the PCE; Equipment do not emitt molten metal; Enclosures do not deform to cause non-compliance with the standard. Pass the dielectric test.</p> <p>Tested on model HYD 6000-EP</p>
--

7.3.6.3.3	TABLE: protective equipotential bonding ;				P
Measured between:	Test current (A)	Voltage drop (V)	Resistance (mΩ)	result	
Enclosure to earthing terminal	60	0.65	10.8	PASS	
supplementary information The alternative of 7.3.6.3.5 was considered.					

7.3.6.3.7	TABLE: touch current measurement			P
Measured between:	Measured (mA)	Limit (mA)	Comments/conditions	
Live parts and enclosure	0.52	3.5	N/A	
Live parts and communication ports	2.05	3.5	N/A	
supplementary information				

7.3.7	TABLE: clearance and creepage distance measurements						P
clearance cl and creepage distance dcr at / of:	Up (V)	U r.m.s. (V)	required cl (mm)	cl (mm)	required dcr (mm)	dcr (mm)	
PV,AC circuits go through the optocouple U16, U19, U20 to communication circuits and adjacent circuits on output PCB board (RI)	600Vdc	600V 230	5.5	6.54	5.5	6.54	
PV,AC circuits go through the optocouple U56, U53, U63, U46, U51, U52 to communication circuits and adjacent circuits on Power PCB board (RI)	600Vdc	600V 230	5.5	7.01	5.5	7.01	
PV,AC circuits go through the Transformer TX1 to communication circuits and adjacent circuits	600Vdc	600V 230	5.5	5.83	5.5	5.83	

IEC 62109-1			
Clause	Requirement – Test	Result – Remark	Verdict

7.3.7	TABLE: clearance and creepage distance measurements					P
on Power PCB board (RI)						
Y capacitor (C20, C132, C138, C142, C148, C115, C105, C97, C92, C113, C104, C114) to earthing on output PCB board (BI)	600Vdc	600V 230	3.2	5.02	3.2	5.02
Relay (RL1, RL2, RL4, RL5 RY6) two polarity on output PCB board (BI)	600Vdc	600V 230	3.2	3.30	3.2	3.30
PCB board to metal enclosure (BI)	600Vdc	600V 230	3.2	9.23	6.3	9.23
IGBT go through the insulation sheet to metal screw enclosure (BI)	600Vdc	600V 230	3.2	7.54	6.3	7.54

Remarks:

1) FI: function insulation BI: Basic insulation SI: Supplementary insulation RI: Reinforced insulation
The double side PCB layout is considered and evaluated.

7.3.7	TABLE: distance through insulation measurement				P
distance through insulation di at/of:	U r.m.s. (V)	test voltage (V)	required di (mm)	di (mm)	
Optocoupler	230Vac 600Vdc	5090Vdc	--	certified	
Insulation sheet	230Vac 600Vdc	5090Vdc	--	0.13	

7.5	TABLE: electric strength measurements, impulse voltage test and partial discharge test			P
test voltage applied between:	test voltage (V)	impulse withstand voltage (V)	partial discharge extinction voltage (V)	result
DC input terminal to earthed enclosure	2545Vdc	4000	N/A	No breakdown
AC Output terminal to communication port	5090Vdc	6000	N/A	No breakdown
DC input terminal to communication port	5090Vdc	6000	N/A	No breakdown
Battery terminal to earthed enclosure	2545Vdc	4000	N/A	No breakdown
Insulation sheet	2545Vdc	4000	N/A	No breakdown
One layer of insulation tape	5090Vdc	6000	N/A	No breakdown
Relay pin 3 to pin 4	2545Vdc	4000	N/A	No breakdown

IEC 62109-1			
Clause	Requirement – Test	Result – Remark	Verdict

9.2	TABLE: Limited power sources	N/A	
-----	-------------------------------------	-----	--

Circuit output tested:

Note: Measured Uoc (V) with all load circuits disconnected:

Components	Sample No.	Uoc (V)	I _{sc} (A)		VA	
			Meas.	Limit	Meas.	Limit

supplementary information:

Sc=Short circuit, Oc=Open circuit

IEC 62109-1			
Clause	Requirement – Test	Result – Remark	Verdict

14	TABLE: list of critical components					P
object/part No.	manufacturer/ trademark	type/model	technical data	standard	mark(s) of conformity ¹⁾	
Metal Enclosure	Various	Various	Min. thickness : 1.2mm	IEC/EN 62109-1 IEC/EN 62109-2	Tested with appliance	
Heat-sink (the rear side of enclosure)	Various	Various	Metal, overall measured: L: 480mm, W: 343mm, H: 60mm	IEC/EN 62109-1 IEC/EN 62109-2	Tested with appliance	
DC breaker	Santon	XBE3310-2-D XBE+3310-2-D	650V dc, 25A dc, Max.70°C	EN 60947- 3/A1/C1	DEKRA: 2199573.01	
(Alternative)	ProJoy Electric SRL.	PEDS150R- HM25-3	25A, 600VDC, Max.75°C	EN 60947- 3:2009+A1	TUV R50389807	
PV connector	Amphenol Industrial operations	Helios H4 series	1000Vdc, 40A, Max. 90 C, IP 68	DIN V VDE V 0126-3/12.2006	TUV R50157783	
Battery terminal	SHENZHEN SUCCEED ELECTRONICS TECHNOLOGY CO.,LTD	TR100-01-2P	AC600V, 100A, Max. 120 C	UL 1059, UL 486E	UL E332956	
Internal wiring (DC-in)	Various	1015	Min.8AWG,600 V,105°C,VW-1	UL 758	UL	
Internal wiring (AC-out)	Various	1015	Min.12AWG,60 0V,105°C,VW-1	UL 758	UL	
Earthing wire	Various	1015	Min. 12AWG, 600V, 105°C, VW-1	UL 1015	UL	
Battery wire	Various	1015	Min.8AWG, 600V, 105°C, VW-1	UL 1015	UL	
AC Grid terminal	SHENZHEN SUCCEED ELECTRONICS TECHNOLOGY CO.,LTD	TR-6N-01-NP - XX-T(f)	600V, 50A, Max. 105°C	UL 1059, UL 486E	UL E332956	
Plastic sheet for Transistors	BERGQUIST CO	K-10#	150°C, VTM-0, min. 0.13mm thickness	UL 94	UL E59150	
PCB	Various	Various	Min.130°C, min. V-0, CTI≥175	UL 796	UL	
LCD panel	MACDERMID AUTOTYPE	Autotex XE(f2)	105°C, V-0, min. 0.2mm	UL 94 UL 746C	UL E165805	

IEC 62109-1			
Clause	Requirement – Test	Result – Remark	Verdict

14	TABLE: list of critical components					P
object/part No.	manufacturer/ trademark	type/model	technical data	standard	mark(s) of conformity ¹⁾	
	LTD		thickness			
Boost inductor (L1, L2)	Huizhou Baohui Electronics Technology Co., Ltd	115-18-073E	0.84mH, Class B	IEC/EN 62109-1 IEC/EN 62109-2	Tested with appliance	
- Lead wire	Various	Various	10AWG, 600V, 105°C, VW-1	UL 758	UL	
-Winding	All	All accepted	130°C	UL 1446	UL	
- VARNISH	SUZHOU TAIHU ELECTRIC ADVANCED MATERIAL CO LTD	T-4260(a)	130 °C	UL 746 UL94	UL E228349	
- Winding tape	JINGJIANG YAHUA PRESSURE SENSITIVE GLUE	PF- CT-	Min 130°C	UL 510	UL E165111	
- Margin tape	JINGJIANG YAHUA PRESSURE SENSITIVE GLUE	WF-	130 °C	UL 510	UL E165111	
INV Inductor (L4, L5)	Huizhou Baohui Electronics Technology Co., Ltd	SH-T016	840µH, ClassB	IEC/EN 62109-1 IEC/EN 62109-2	Tested with appliance	
- Lead wire	Various	Various	10AWG, 600V, 105°C, VW-1	UL 758	UL	
-Winding	All	All accepted	130°C	UL 1446	UL	
- VARNISH	SUZHOU TAIHU ELECTRIC ADVANCED MATERIAL CO LTD	T-4260(a)	130 °C	UL 746 UL94	UL E228349	
- Winding tape	JINGJIANG YAHUA PRESSURE SENSITIVE GLUE	PF- CT-	Min 130°C	UL 510	UL E165111	
- Margin tape	JINGJIANG YAHUA PRESSURE	WF-	130 °C	UL 510	UL E165111	

IEC 62109-1			
Clause	Requirement – Test	Result – Remark	Verdict

14	TABLE: list of critical components					P
object/part No.	manufacturer/ trademark	type/model	technical data	standard	mark(s) of conformity ¹⁾	
	SENSITIVE GLUE					
-Tube	SHENZHEN WAHCHANGW EI INDUSTRIAL CO LTD	SGS-25	200°C	UL 1441	E233804	
SPS transformer (TX1)	Huizhou Baohui Electronics Technology Co., Ltd	SH-T008	Class B	IEC/EN 62109-1 IEC/EN 62109-2	Tested with appliance	
-Bobbin	SUMITOMO BAKELITE CO LTD	PM-9820 PM-9630	150°C	UL 94	E41429	
-Winding	Various	Various	130°C	UL 1446	UL	
--Tape	JINGJIANG YAHUA PRESSURE SENSITIVE GLUE CO LTD	CT-	130°C	UL 510	UL E165111	
- Margin Tape	Jingjiang Yahua Pressure Sensitive Glue Co Ltd	WF-	130°C	UL 510	UL E165111	
-Expoxy	DONGGUAN EATTO ELECTRONIC MATERIAL CO LTD	3300A-1/B-1	V-0, 130 C	UL 746 UL94	UL E218090	
AC Filiter (L14)	Huizhou Baohui Electronics Technology Co., Ltd	2.0D*2/T31*19* 15C(M12K)	0.5mH, Class B	IEC/EN 62109-1 IEC/EN 62109-2	Tested with appliance	
-Magnet Wire	TONGLING JINGDA SPECIAL MAGNET WIRE CO LTD	QZY-2	130°C	UL 1446	UL E223994	
- VARNISH	SUZHOU TAIHU ELECTRIC ADVANCED MATERIAL CO LTD	T-4260(a)	130 °C	UL 746 UL94	UL E228349	
--Tape	JINGJIANG	CT-	130°C	UL 510	UL E165111	

IEC 62109-1			
Clause	Requirement – Test	Result – Remark	Verdict

14	TABLE: list of critical components					P
object/part No.	manufacturer/ trademark	type/model	technical data	standard	mark(s) of conformity ¹⁾	
	YAHUA PRESSURE SENSITIVE GLUE CO LTD					
DC Filtiter (L14, L15)	Bo Luo Da Xin Electronic Co., Ltd	2.0D*2/T31*19* 15C(M12K)	0.5mH, Class B	IEC/EN 62109-1 IEC/EN 62109-2	Tested with appliance	
-Magnet Wire	TONGLING JINGDA SPECIAL MAGNET WIRE CO LTD	QZY-2	130°C	UL 1446	UL E223994	
- VARNISH	SUZHOU TAIHU ELECTRIC ADVANCED MATERIAL CO LTD	T-4260(a)	130 °C	UL 746 UL94	UL E228349	
--Tape	JINGJIANG YAHUA PRESSURE SENSITIVE GLUE CO LTD	CT-	130°C	UL 510	UL E165111	
BUS Capacitor (C1, C2, C3, C4, C7, C8, C9, C10)	Unielecs Co.,LTD	LLN2F102M355 0	1000µF, 315V, Max.105°C	IEC/EN 62109-1 IEC/EN 62109-2	Tested with appliance	
(Alternative)	Nichicon Co., Ltd.	LGX2F102MEL EZS	1000µF, 315V, Max.105°C	IEC/EN 62109-1 IEC/EN 62109-2	Tested with appliance	
(Alternative)	Nantong jianghai Capacitor Co., Ltd.	ECS2FBB102M VN350050V	1000µF, 315V, Max.105°C	IEC/EN 62109-1 IEC/EN 62109-2	Tested with appliance	
(Alternative)	LELON ELECTRONICS CORP.	LSK102M2F-- A3550	1000µF, 315V, Max.105°C	IEC/EN 62109-1 IEC/EN 62109-2	Tested with appliance	
FAN	Minebea Co.,LTD	06025SA-12S- AT-0260*60*25	12VDC, 7000r.p.m,1650 0H@80°C	UL94	E98836	
DC-LINK Capacitor (C13)	Xiamen FARA Electronic Co.,Ltd	C3D2H606KF0 AC00	60µF, 500V, 105°C	EN61071:2007; EN61881- 1:2011	TUV R50266108	

IEC 62109-1			
Clause	Requirement – Test	Result – Remark	Verdict

14	TABLE: list of critical components					P
object/part No.	manufacturer/ trademark	type/model	technical data	standard	mark(s) of conformity ¹⁾	
Y capacitor (C30,C31,C337)	Shantou High- New Technology Dev. Zone Songtian Enterprise Co., Ltd	CE	10nF,Y2 250Vac, Max.125°C	EN 60384- 14:2013; IEC 60384-14(ed.4)	VDE 40025748	
Y capacitor (C20,C92,C97, C104,C105,C10 6,C113,C114,C 115,C132,C134, C137,C138,C14 1,C142,C147,C 148)	Shantou High- New Technology Dev. Zone Songtian Enterprise Co., Ltd	CD	Y1, 4.7nF, 400Vac, Max.125°C	EN 60384- 14:2013; IEC 60384-14(ed.4)	VDE 40025754	
X2 capacitor (C103,C112)	Shantou High- New Technology Dev. Zone Songtian Enterprise Co., Ltd	MPX	1µF, 275V, Max.110°C	EN 60384- 14:2013; IEC 60384-14(ed.4)	VDE 40034679	
Current transducer (HL1)	LEM	CASR 25-NP	IPN: ±25A; Vout: ±5V Max.: 85°C	IEC/EN 62109-1 IEC/EN 62109-2	Tested with appliance	
IGBT (Q1, Q2, Q3, Q4, Q5, Q6, Q7, Q12, Q25, Q26)	Fairchild Semiconductor Corporation	FGA40N65SMD	650V, 40A, 155°C	IEC/EN 62109-1 IEC/EN 62109-2	Tested with appliance	
(Alternative)	ST Microelectronics	STGWT40H65D FB	650V, 40A, 155°C	IEC/EN 62109-1 IEC/EN 62109-2	Tested with appliance	
(Alternative)	IXYS CORPORATIO N	IXXH40N65B4H 1	650V, 40A, 155°C	IEC/EN 62109-1 IEC/EN 62109-2	Tested with appliance	
IGBT (QD1, QD2, QD3, QD4)	Infineon Semiconductor Corporation	IKW40N65H5	650V, 46A, 155°C	IEC/EN 62109-1 IEC/EN 62109-2	Tested with appliance	

IEC 62109-1			
Clause	Requirement – Test	Result – Remark	Verdict

14	TABLE: list of critical components					P
object/part No.	manufacturer/ trademark	type/model	technical data	standard	mark(s) of conformity ¹⁾	
MOSFET (Q16, Q17, Q18, Q19, Q21, Q22, Q23, Q24)	Fairchild Semiconductor Corporation	FDP027N08B	80V, 120A, 175°C	IEC/EN 62109-1 IEC/EN 62109-2	Tested with appliance	
(Alternative)	ST Microelectronics	STP270N8F7	80V, 180A, 155°C	IEC/EN 62109-1 IEC/EN 62109-2	Tested with appliance	
Doide (D13, D12)	IXYS CORPORATIO N	DSEI30-06A	37A, 600V, , 155°C	IEC/EN 62109-1 IEC/EN 62109-2	Tested with appliance	
(Alternative)	MICROSEMI CORPORATIO N	APT30DQ60BG	30A, 600V, , 155°C	IEC/EN 62109-1 IEC/EN 62109-2	Tested with appliance	
Relay (RL1, RL2, RL3, RL4, RL5, RL6)	Xiamen Hongfa Electroacoustics Co., Ltd.	HF161F-W/12- HT	31A, 250Vac, 12Vdc, 85°C	IEC/EN 61810-1	VDE 40031410	
Optocoupler (U14,U15,U16, U17,U19,U20)	Liteon optoelectronics	LTV816	Di ≥ 0.4mm, Internall di ≥ 7.0mm, External di ≥ 7.62mm, AC 8000V, 115°C	IEC 60747-5-5	VDE 40015248	
Optocoupler U2,U3,U13,U14, U17,U18,U26,U 27,U31,U32	TOSHIBA Semiconductor Corporation	TLP350 (D4- TP1.F)	Di ≥ 0.4mm Internal di ≥ 7.0mm External di ≥ 7.0mm, AC 5000V, reinforced Insulation 100°C	DIN EN 60747- 5-2	VDE 40009302	
(Alternative)	TOSHIBA	TLP352(TP1,F)	Di ≥ 0.4mm Internall di ≥	DIN EN 60747- 5-2	VDE 40009302	

IEC 62109-1			
Clause	Requirement – Test	Result – Remark	Verdict

14	TABLE: list of critical components					P
object/part No.	manufacturer/ trademark	type/model	technical data	standard	mark(s) of conformity ¹⁾	
			7.0mm External di ≅ 7.0mm, 125°C			
GFCI (L10)	Huizhou Baohui Electronics Technology Co., Ltd	W539	Class B	IEC/EN 62109-1 IEC/EN 62109-2	Tested with appliance	
-Expoxy	DONGGUAN EATTO ELECTRONIC MATERIAL CO LTD	3300A-1/B-1	V-0, 130°C	UL 746 UL94	UL E218090	
(Alternative)	HUI ZHOU QIANG DA ELECTRONICS INDUSTRY CO LTD	QDJ600(#)	V-0, 130°C	UL 746 UL94	UL E351561	
-Tape	SHENZHEN WOER HEAT- SHRINKABLE MATERIAL CO LTD	WF	200°C	UL224	UL 203950	
Transformer (TX2 in communication board)	Huizhou Baohui Electronics Technology Co., Ltd	SH-T010	Class B	IEC/EN 62109-1 IEC/EN 62109-2	Tested with appliance	
-Bobbin	CHANG CHUN PLASTICS CO LTD	PM-9820 PM-9830	V-0, min. thickness: 0.75mm, 150°C	UL 94	UL E41429	
-Margin tape	Jingjiang Yahua Pressure Sensitive Glue Co Ltd	WF	130° C	UL 510	UL E165111	

IEC 62109-1					
Clause	Requirement – Test			Result – Remark	Verdict
Master MCU	TI	TMS320F28075 PTP	150M, Max 105°C	IEC/EN 62109-1 IEC/EN 62109-2	Tested with appliance
Slave MCU	NXP	LPC804M101JD H24	60M, Max 105°C	IEC/EN 62109-1 IEC/EN 62109-2	Tested with appliance
1) an asterisk indicates a mark which assures the agreed level of surveillance					

Appendix 1: Photos



Overview

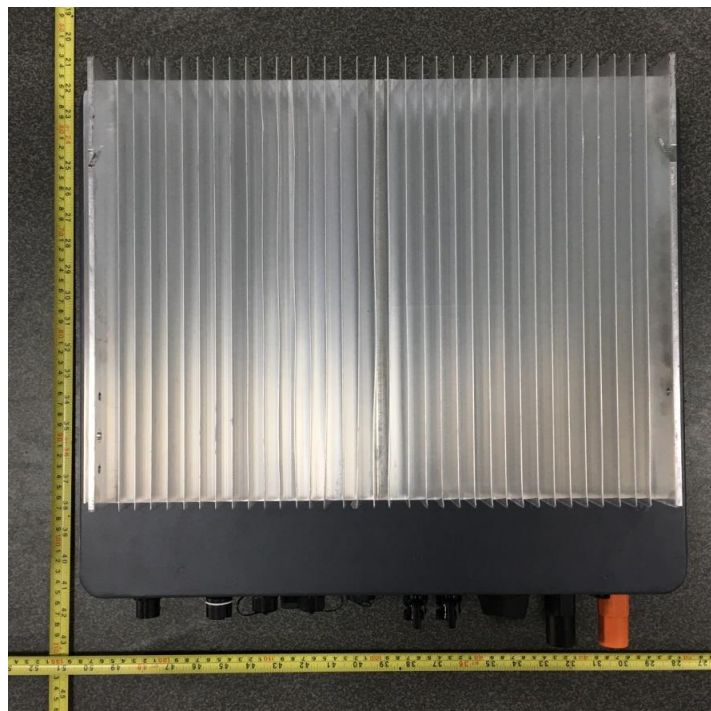

Bottom view

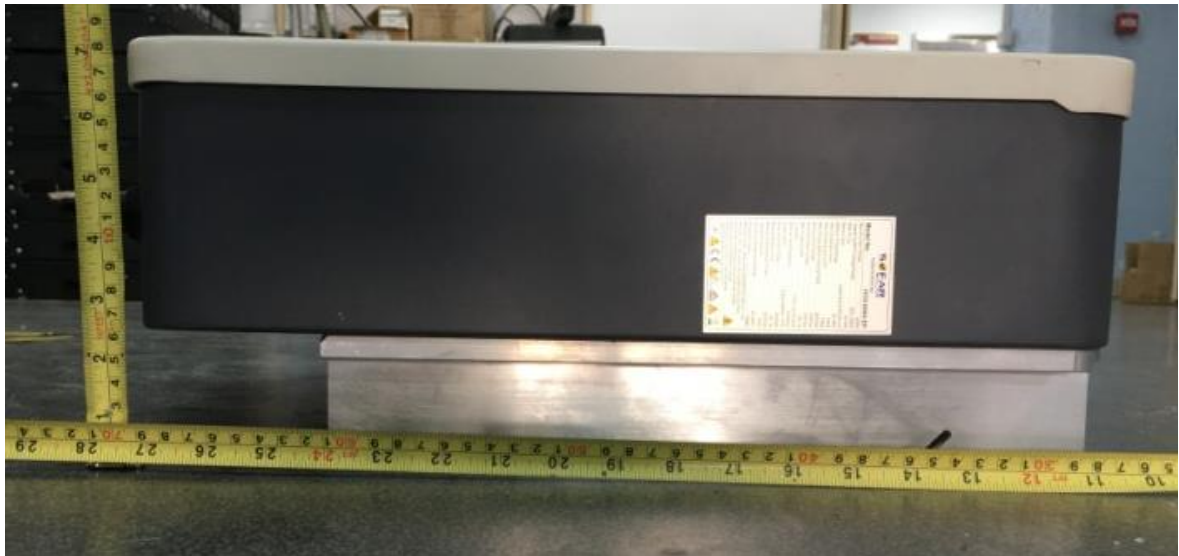

Side view



Connection view

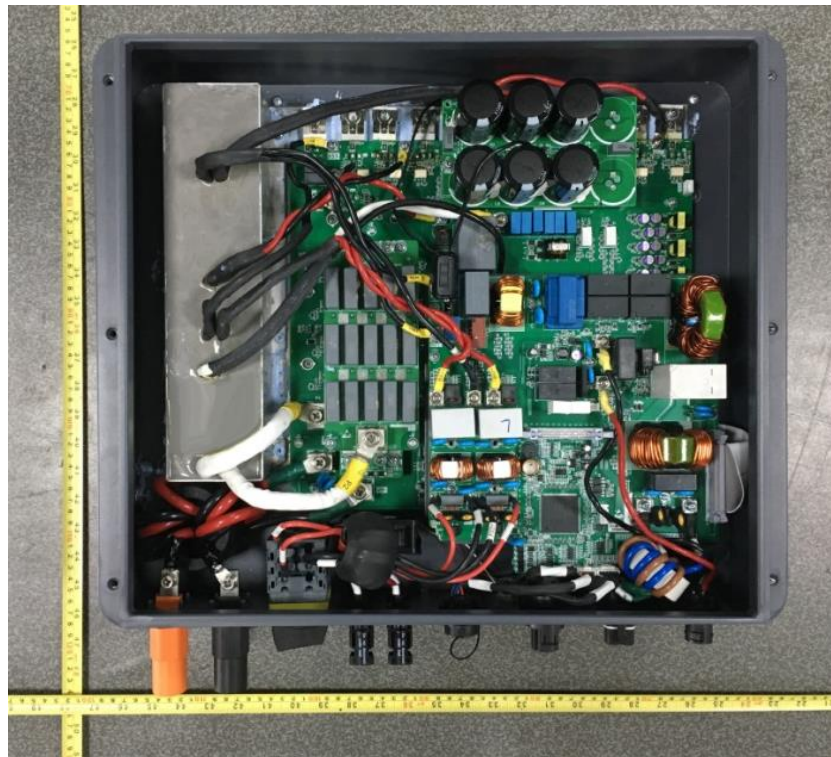

Internal view for model HYD 4000-EP, HYD 3600-EP, HYD 3000-EP

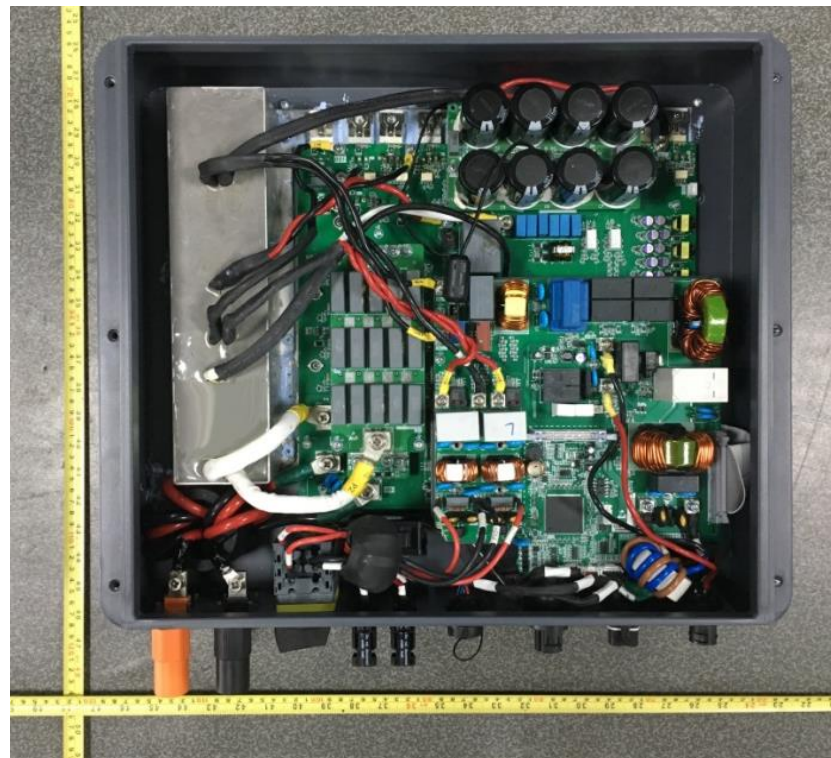

Internal view for model HYD 4600-EP, HYD 5000-EP, HYD 6000-EP

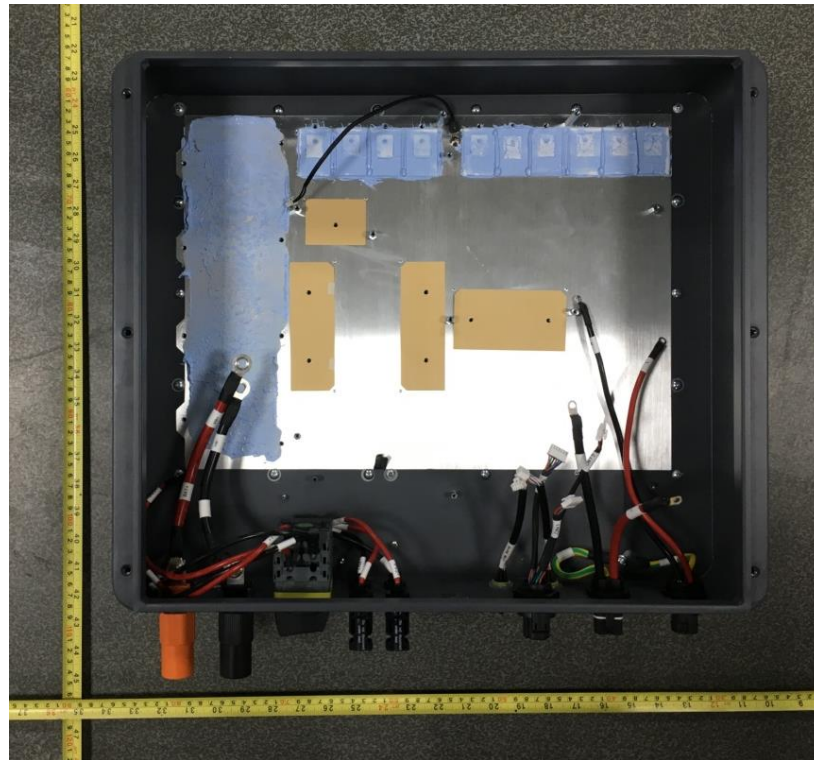

Internal view



Earthing view

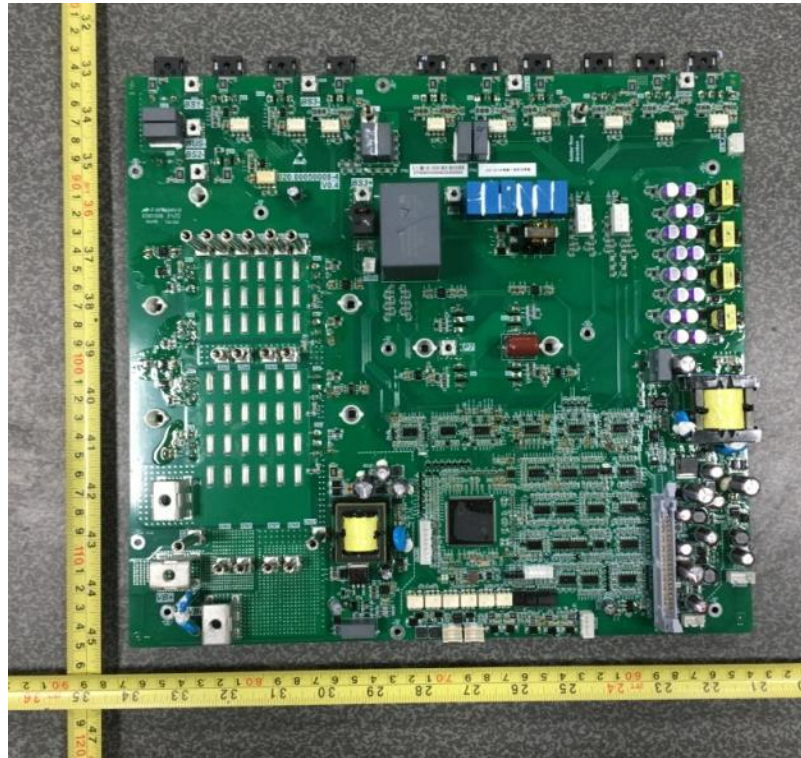

Power board view (Components side)

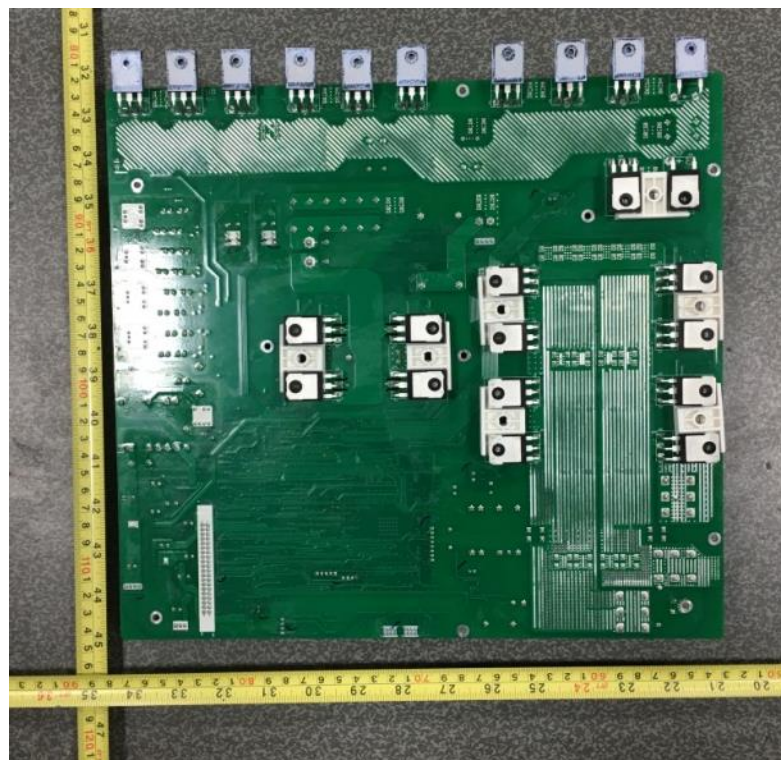

Power board view (Soldered side)

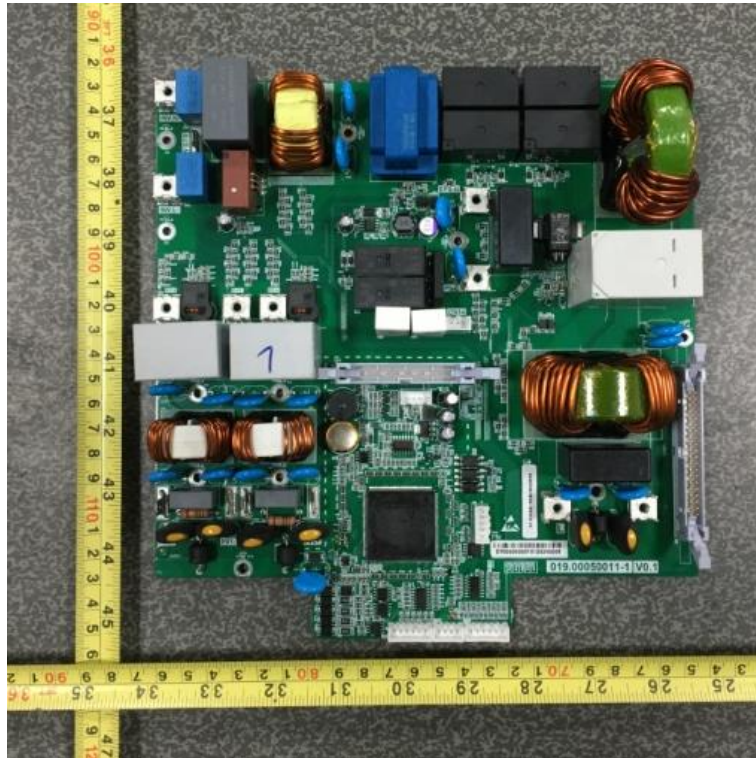

Input/output and connection board view (Components side)

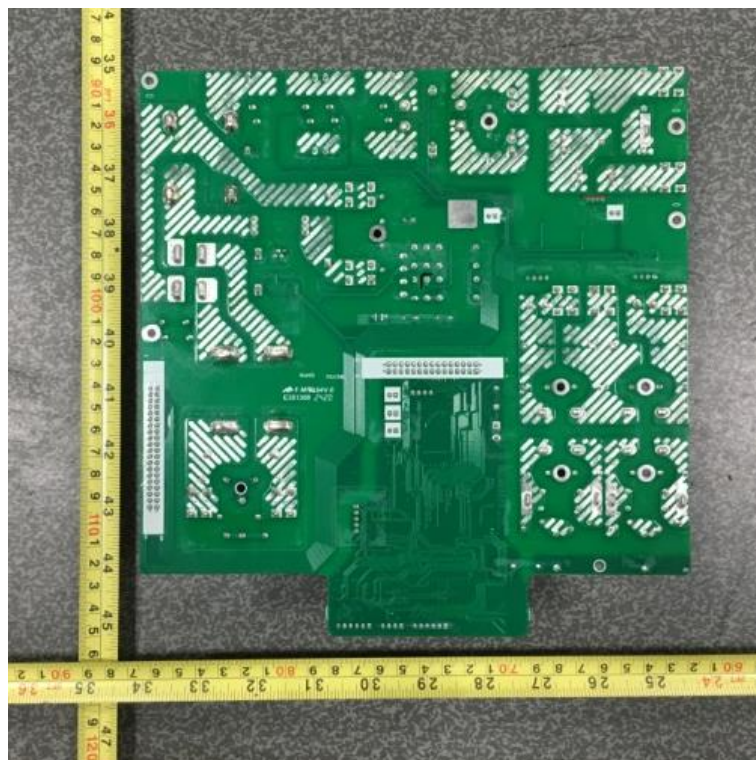

Input/output and connection board view (Soldered side)



Filter board view (Components side)

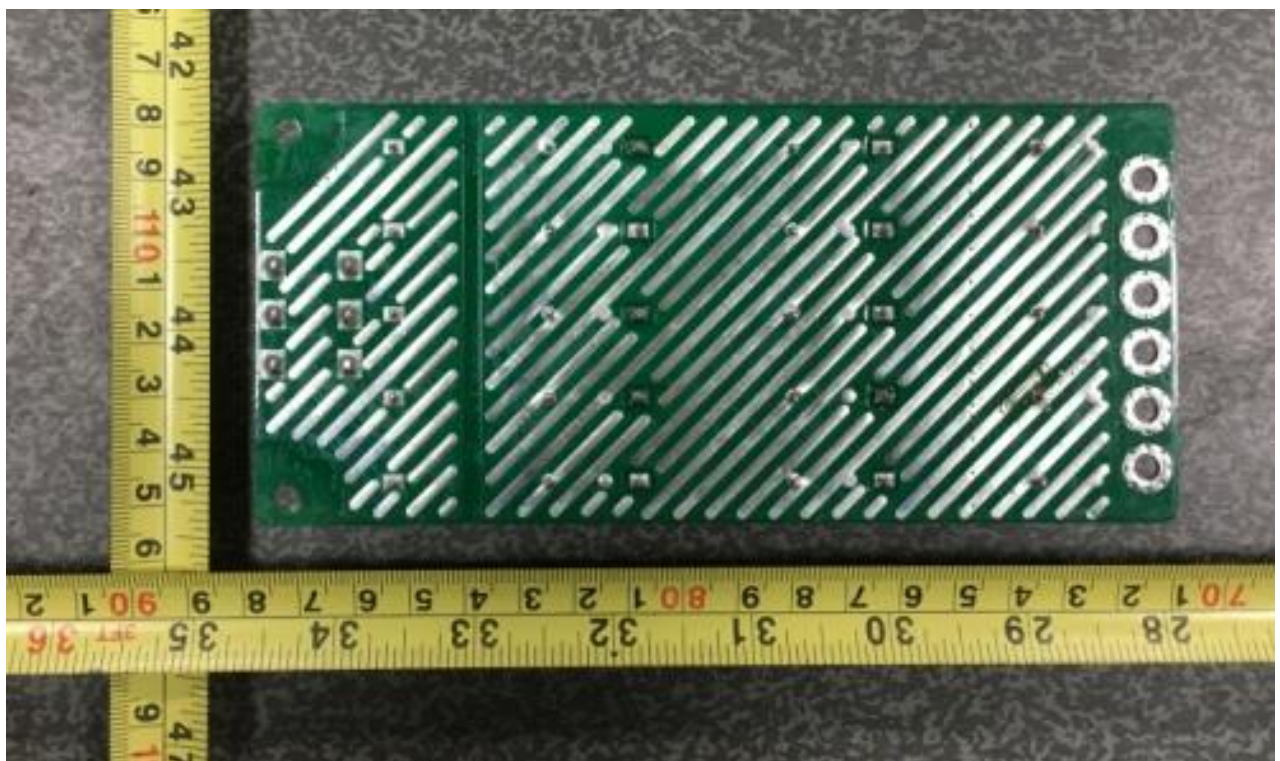

Filter board view (Soldered side)



Capacitor board for model HYD 4600-EP, HYD 5000-EP, HYD 6000-EP

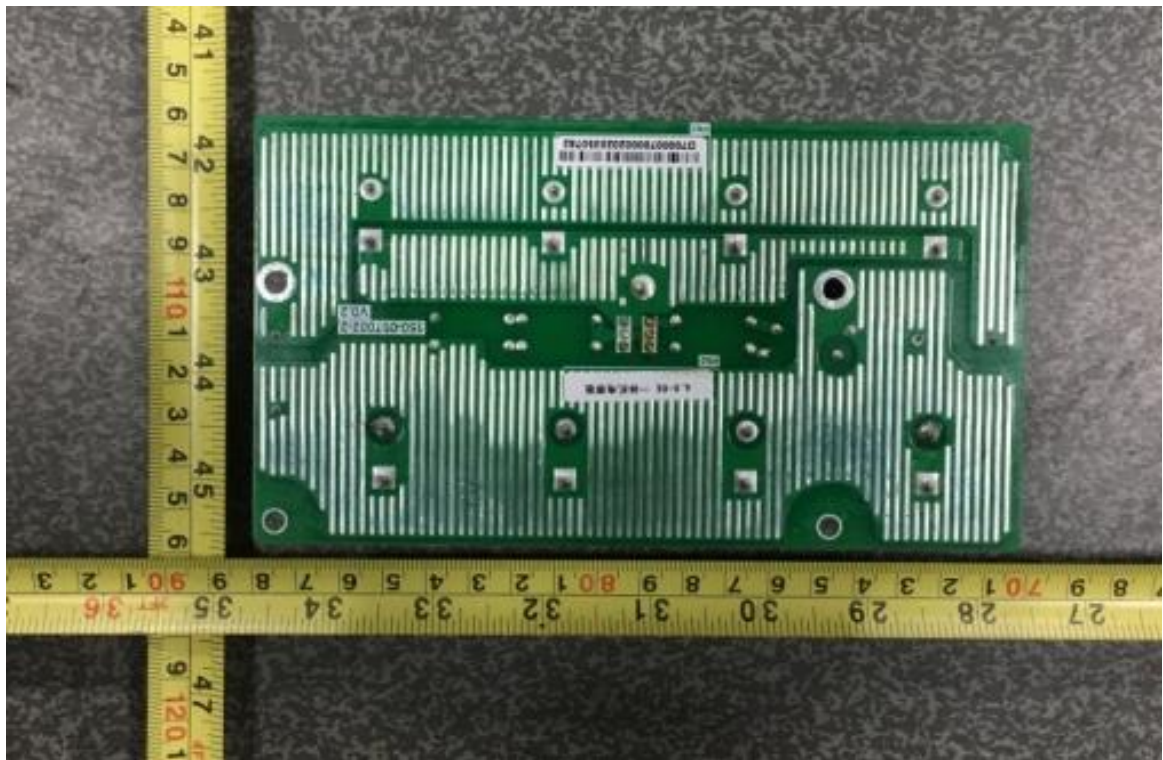

Capacitor board for model HYD 4600-EP, HYD 5000-EP, HYD 6000-EP



Capacitor board for model HYD 3600-EP, HYD 3000-EP, HYD 4000-EP

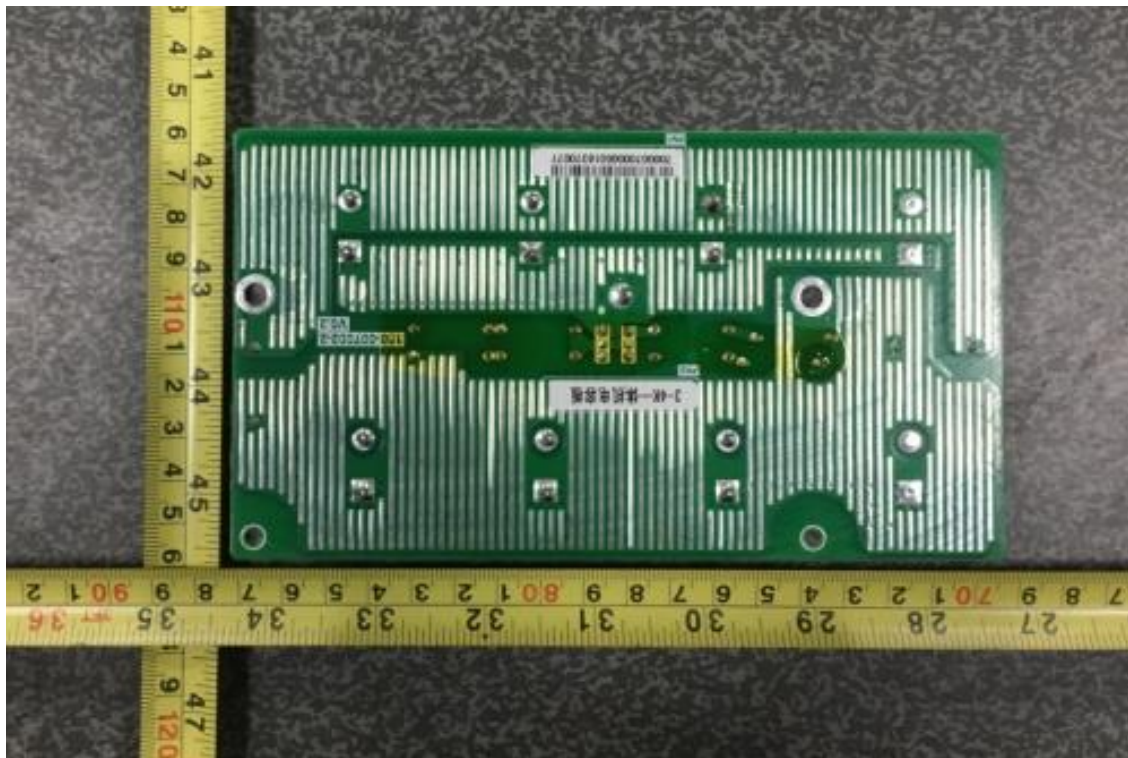

Capacitor board for model HYD 3600-EP, HYD 3000-EP, HYD 4000-EP

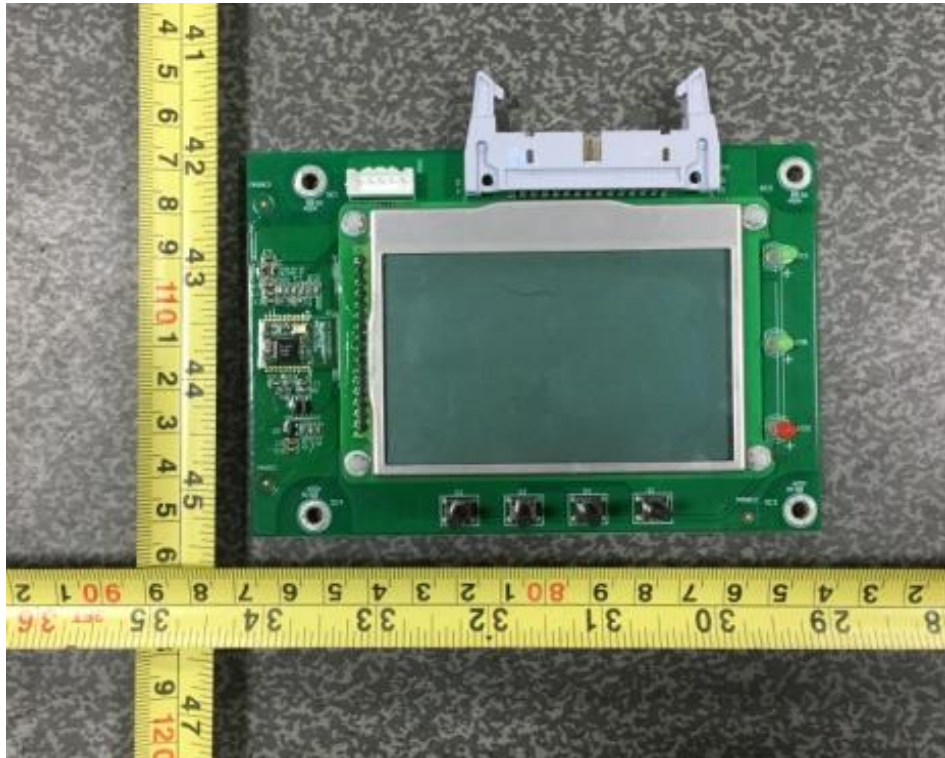

Display board view

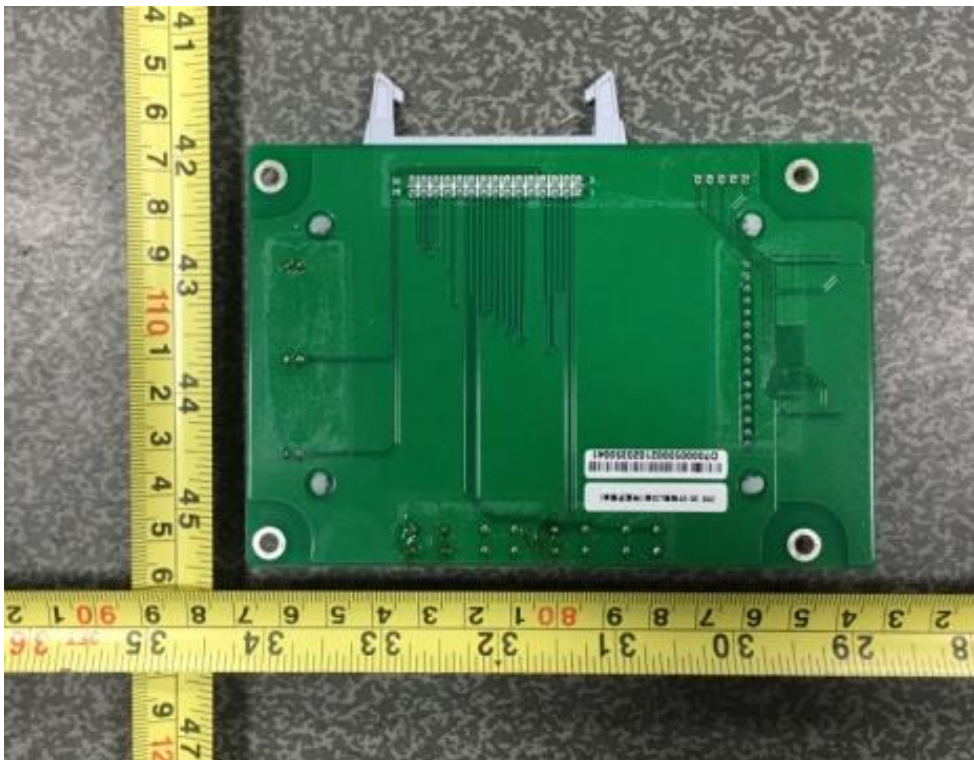

Display board view

(End of Report)